

APRIL 2024

The bigger the better?

How battery size affects real-world energy consumption, cost of ownership, and life-cycle emissions of electric vehicles

CAROLINA POUPINHA, JAN DORNOFF

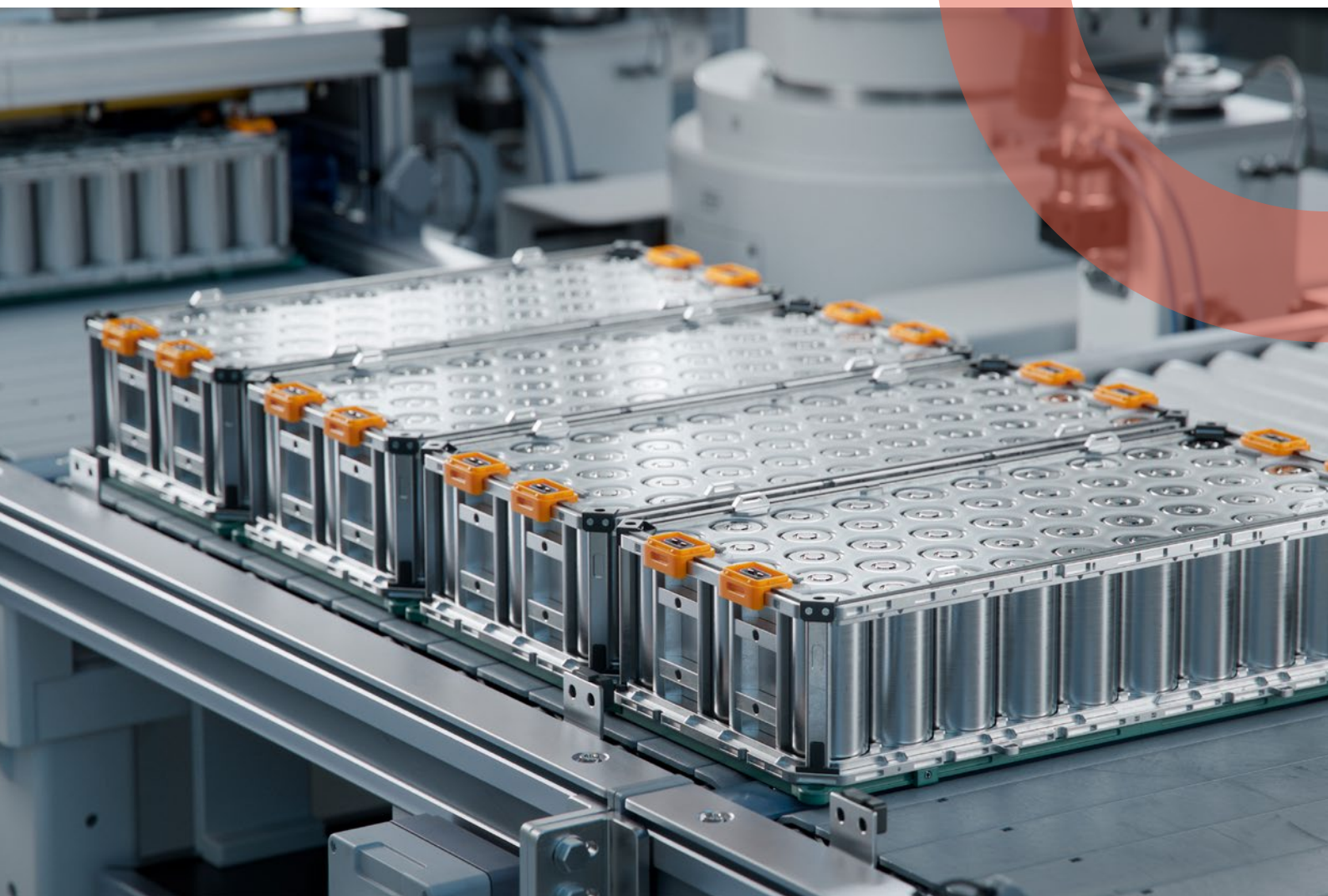

ACKNOWLEDGMENTS

The authors express their gratitude to all reviewers of this report for their guidance and constructive comments, with special thanks to Aditya Mahalana, Eyal Li, Georg Bieker, Hongyang Cui, Hussein Basma, Kyle Morrison, and Peter Mock of ICCT, Philipp Rosner of Technical University of Munich, and Yoann Gimbert of Transport & Environment. Any errors are the authors' own. Funding for this work was generously provided by the European Climate Foundation.

Editor: Amy Smorodin

For additional information:
International Council on Clean Transportation Europe
Fasanenstrasse 85, 10623 Berlin, Germany

communications@theicct.org | www.theicct.org | [@TheICCT](https://twitter.com/TheICCT)

© 2024 International Council on Clean Transportation (ID 80)

EXECUTIVE SUMMARY

The range of battery electric vehicles (BEVs) has continuously increased over the past decade, and projections indicate this trend will continue. However, enabling a longer range requires a larger battery, which can negatively impact energy consumption and lead to higher greenhouse gas (GHG) emissions. Installing a larger battery also substantially increases the vehicle price, thereby making BEVs less affordable for many consumers. An alternative to purchasing a longer-range BEV with a heavy and cost-intensive battery is opting for a smaller battery and using fast charging during occasional long-distance trips.

In this study, we assess the impact of four different battery sizes in the same vehicle model and the resulting changes in charging strategy, energy consumption, life-cycle GHG emissions, total cost of ownership, and user convenience. The study is performed for three generic user types: an urban commuter, a rural commuter, and a frequent long-distance driver. We model the compact BEV Volkswagen ID.3 and simulate its use over the period of one calendar year. We examine the effect of battery capacity on vehicle mass, the type of charging, and the thermal management system for the cabin and battery, taking into account daily variations in ambient temperature and solar irradiation.

The simulation results, illustrated in Figure ES1, show that energy consumption increases with increasing battery capacity, while the number of en-route fast charging stops decreases. For urban and rural commuters, these charging stops occur primarily during long-distance leisure trips taken on 2% of the days in one year. Only the frequent long-distance driver, who performs long-distance trips on 27% of the days over a year, benefits notably from the increase in battery size.

Figure ES1

Annual average energy consumption and number of en-route fast charges for the simulated compact battery electric vehicle

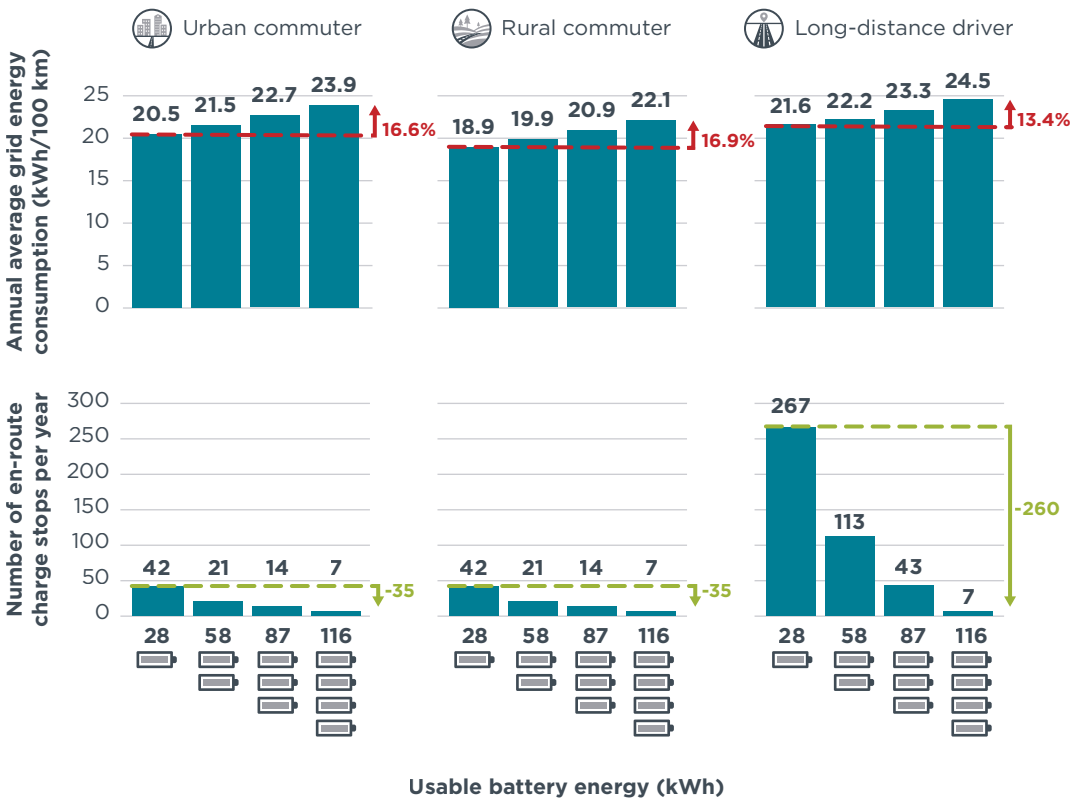

THE INTERNATIONAL COUNCIL ON CLEAN TRANSPORTATION [THEICCT.ORG](https://www.theicct.org)

Based on the simulation results, we calculate the life-cycle GHG emissions and the total cost of ownership for a 4-year holding period by the first vehicle owner. The life-cycle GHG emissions and the total cost of ownership are affected by increased energy consumption, higher GHG emissions from production, and a higher battery price. As Figure ES2 shows, doubling the BEV real-world range from 250 km to 500 km increases the annual average energy consumption between 8% and 10% for the three user types. At the same time, life-cycle GHG emissions increase between 15% and 20%. The cost per kilometer is 15% higher for the long-distance driver, about 23% higher for the urban commuter, and 20% higher for the rural commuter. User convenience, expressed by the number of en-route charge stops, does not improve for the urban and rural commuters on commute days when doubling the range. For the long-distance driver, one charge stop per commute day on average is avoided. For the few long-distance leisure trips these drivers take per year, the number of en-route charges decreases from four to two for the urban commuter and the long-distance driver, while decreasing from five to two for the rural commuter.

Figure ES2

Costs and benefits of doubling the average annual real-world range; a comparison for three different user types

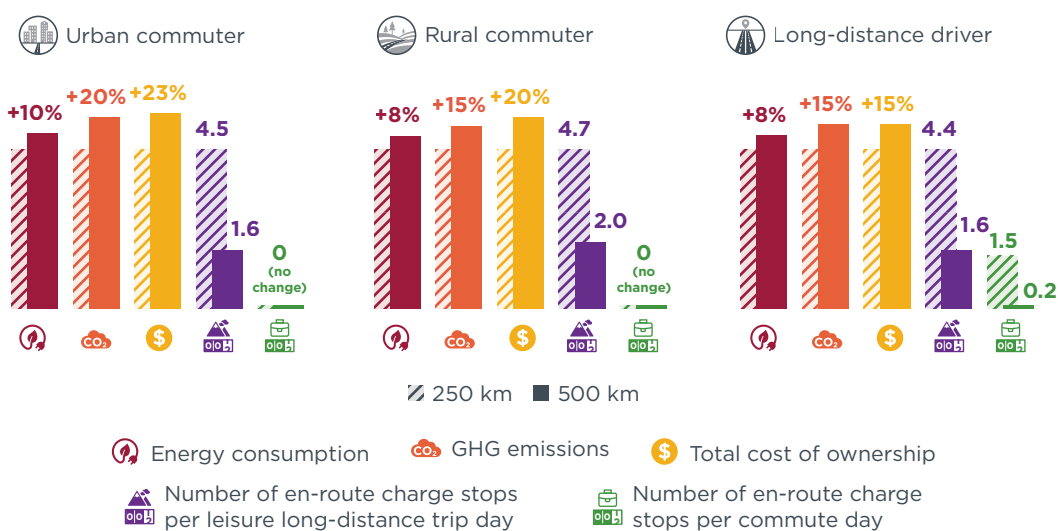

THE INTERNATIONAL COUNCIL ON CLEAN TRANSPORTATION THEICT.ORG

Based on the results of the study, we arrive at the following conclusions and offer our recommendations:

Most of the time, a larger battery does not provide additional benefits for the urban and rural commuter in terms of avoided en-route fast charging stops. Fast charging along the route is only required when conducting long-distance trips, which in the case of our simulation represent less than 2% of days throughout the year.

For the user types considered, a smaller battery combined with fast charging is more cost efficient than a larger battery. Despite the higher electricity price associated with more frequent fast charging, a smaller battery results in lower energy consumption, a lower vehicle-purchase price, and a lower total cost of ownership.

Using a small battery and reducing electric energy consumption is essential for achieving low BEV life-cycle greenhouse gas emissions. Life-cycle greenhouse gas emissions of BEVs increase with battery size. To reduce the environmental footprint of

BEVs, it is essential to provide consumers with sufficient information for choosing the battery size that fits their needs.

BEV energy consumption and range are strongly affected by ambient conditions and vehicle usage. Due to the energy consumption of the heating and air conditioning system, as well as of the battery thermal management system, the average energy consumption and the available range vary substantially from month to month. This effect is especially pronounced for users who frequently drive short-distance trips.

Policymakers should consider collecting real-world energy consumption data from BEVs using on-board fuel and energy consumption monitoring (OBFCEM) devices. The simulated real-world energy consumption is 29% to 44% higher than the type-approval value. For verifying the representativeness of BEV type-approval values, collecting reliable real-world energy consumption is essential. It is also a prerequisite for providing consumers with comprehensive information, determining life-cycle emissions, and assessing the impact of electric vehicle energy consumption limits. These analyses could be performed by the European Commission as defined in the CO₂ standards for cars and vans.

TABLE OF CONTENTS

Executive summary	i
Abbreviations	v
1. Introduction	1
2. Modeling methodology	3
2.1. Vehicle model used for simulation	3
2.2. Simulation model design	4
2.3. Calibration of the simulation model.....	8
2.4. Simulated vehicle usage scenarios	10
2.5. How simulation results are used to assess the effects of battery size	13
3. Analysis results	17
3.1. Annual average energy consumption.....	17
3.2. Breakdown of average energy consumption by vehicle component.....	19
3.3. Effects of user behavior and ambient conditions on energy consumption.....	22
3.4. How battery size affects the number of en-route charging stops as a metric for user convenience	24
3.5. Effect of battery size on life-cycle GREENHOUSE GAS emissions	27
3.6. Effect of battery size on the total cost of ownership	28
3.7. Increase of electric range with battery size	31
4. Summary and recommendations	33
References	35
Appendix	37

ABBREVIATIONS

BEV	Battery electric vehicle
COP	Coefficient of performance
GHG	Greenhouse gas
HVAC	Heating, ventilation, and air conditioning
ICEV	Internal combustion engine vehicle
SOC	State of charge
TCO	Total cost of ownership
TMS	Thermal management system
UBE	Usable battery energy
VCU	Vehicle control unit
WLTC	Worldwide harmonized Light vehicles Test Cycle
WLTP	Worldwide harmonized Light vehicles Test Procedure

1. INTRODUCTION

The number of battery electric cars sold in Europe has rapidly increased over the past several years.¹ In 2021, more than 1.2 million new passenger cars sold were battery electric, compared to less than 800,000 in 2020 (Kok & Hall, 2023). While the number of battery-electric vehicles (BEVs) is increasing, the average type-approval electric driving range—defined as the distance a vehicle can travel following the Worldwide harmonized Light vehicles Test Cycle (WLTC) at 23°C when fully charged—is also increasing. As shown in Figure 1, battery electric passenger cars in the European Union in 2020 had a median driving range of 383 km. The range increased to 395 km in 2021 and to 419 km in 2022, which represents a 9.7% increase in range over two years.

Figure 1
Evolution of the WLTC-defined range for passenger cars registered in the EU, 2020–2022



Source: European Environment Agency (2022)

THE INTERNATIONAL COUNCIL ON CLEAN TRANSPORTATION [THEICCT.ORG](https://www.theicct.org)

The increasing range of electric vehicles can help align with consumer preferences and counter range anxiety, which is a driver's fear of depleting the battery before having an opportunity to charge. In a recent survey, 57% of the participants stated a range of 500 km as the minimum for them to consider buying a BEV, and 80% of the survey participants would be satisfied with a range of 650 km or less (Mehlig et al., 2021). However, increasing the range of a specific vehicle requires increasing the battery capacity. Previous ICCT work estimates that the expected decrease in battery production costs could lead to a 20% increase in EV battery capacity between 2021 and 2030 (Bieker, 2021; International Energy Agency, 2022).

Although deploying BEVs with higher battery capacity extends the driving range, it also comes with multiple ramifications:

- » Increasing battery capacity without improving energy density results in a higher vehicle mass, therefore requiring higher energy demand to overcome mass-related resistance. Only part of the higher energy demand can be recuperated through regenerative braking.

¹ In this paper, Europe refers to the 27 European Union Member States, the United Kingdom, and the countries of the European Free Trade Association (EFTA): Iceland, Liechtenstein, Norway, and Switzerland.

- » The production of larger batteries is more energy intensive, resulting in higher GHG emissions.
- » The higher resource demand for bigger batteries strains the market for scarce raw materials, increasing dependency on critical material imports.
- » Because the battery is the single vehicle component associated with the highest cost, increasing the battery capacity results in a higher vehicle price.
- » Greater energy consumption during both battery manufacturing and recharging places a higher demand on electricity generation, increasing GHG emissions.

An alternative to BEVs with longer range is opting for a smaller battery in combination with more frequent use of direct current (DC) fast charging, which significantly reduces the charging time. However, DC charging also comes with disadvantages: the cost of recharging the same amount of energy is higher than for slower alternating current (AC) charging. It also requires thermal control of the battery, which increases the total energy consumption. The optimal battery size and charging strategy therefore depends strongly on the vehicle usage pattern.

In this study, we assess by simulation the impact of different battery sizes and the consequent changes in charging strategies on energy consumption, life-cycle greenhouse gas emissions, total cost of ownership, and user convenience in terms of en-route charge stops per day. The simulation considers the driving behavior of three generic user types to resemble real-world driving under environmental conditions representative for Berlin, Germany, over the period of one year. The simulated BEV model built for this study is based on the popular compact segment ID.3 Pro Performance from Volkswagen.

This paper intends to inform discussions on the energy consumption, life-cycle emissions, and ownership cost of electric vehicles. The presented insights can be useful for the revision of the EU vehicle efficiency label directive (Directive 1999/94/EC, 2000) in 2024 and when the European Commission assesses electric vehicle energy consumption targets in 2026 (Regulation (EU) 2023/851, 2023). Furthermore, the knowledge generated should help to inform the public about the costs and benefits of opting for BEVs of varying range values, enabling consumers to make better-informed purchase decisions.

2. MODELING METHODOLOGY

The goal of this study is to understand how increasing battery size of electric passenger vehicles in Germany affects energy consumption, total cost of ownership, life-cycle GHG emissions, and user convenience for different user scenarios.

In order to simulate a wide range of battery sizes for the same vehicle model, we use the Siemens Simcenter Amesim simulation software. Amesim is a multiphysics system simulation software that enables the combination of multiple physical domains in one model such as electrical, mechanical, and thermal system components. More information on the tool can be found in Basma and Rodríguez (2022).

This section describes the components used for the simulation, including the vehicle model, charging model, modeling of the ambient conditions, as well as the different user profiles and battery charging strategies considered. The methodology used to determine life-cycle emissions and total cost of ownership is also explained, followed by the approach used to assess user convenience.

2.1. VEHICLE MODEL USED FOR SIMULATION

The Volkswagen ID.3, which made up around 24% of European compact BEV sales in 2022 (International Council on Clean Transportation, 2023), is used for the simulation model. The vehicle data was obtained from a recent test project conducted by the Technical University of Munich (TUM) and from the database of German car club ADAC (ADAC, n.d.-a). Table 1 summarizes the main specifications of the vehicle.

Table 1
Technical specifications of the Volkswagen ID.3 Pro Performance modeled for this project

Parameter	Value
Manufacturer	Volkswagen
Car model and variant	ID.3 Pro Performance 58 kWh
Curb weight	1,891 kg
Usable battery energy	58 kWh
Cathode chemistry	Lithium nickel manganese cobalt oxide (NMC)
Pack energy density	162 Wh/kg
Pack volumetric density	1.64 kg/L
Maximum motor power	150 kW
Continuous motor power	70 kW
Maximum motor speed	16,000 rpm
Maximum motor torque	310 Nm
Maximum vehicle speed	160 km/h
Tires	215/45 R20 95T
Final gear ratio	11.53:1
Maximum external charging power	11 kW alternating current (AC) / 100 kW direct current (DC)
WLTP energy consumption	15.4 kWh/100 km
WLTP range	408 km
Aerodynamic drag coefficient	0.267
Frontal area	2.36 m ²

Notes: Data on the WLTP energy consumption, WLTP range, and frontal area data are from the German car club ADAC database (ADAC, n.d.-a). All other data points are from Wassiliadis et al. (2022)

The TUM measurement project produced second-by-second data from laboratory testing under varying ambient conditions. Chassis dynamometer tests performed include the WLTC and the United States Federal Test Procedure (FTP-75) drive cycle, as well as synthetic drive cycles representing urban, rural, and highway driving. We use this data to calibrate and validate our simulation model. However, it is important to note that all tests were performed following the procedural requirements of the WLTP for electric vehicles, that is with heating, ventilation, and air conditioning (HVAC) of the cabin deactivated. Therefore, second-by-second data for verifying the calibration of the thermal management system was not available so aggregated literature information was used for our analysis.

2.2. SIMULATION MODEL DESIGN

Figure 2 illustrates the simulation model developed for this project. The model simulates the vehicle’s longitudinal dynamics, electric powertrain including battery and electric motor, the thermal management system of the battery pack and the cabin, and auxiliary components such as lights and radio. The two charging methods and associated charging losses are also considered. The variation of ambient conditions is reflected by a combination of ambient temperature and solar irradiation. The numbers 1-11 in Figure 2 indicate the locations where energy consumption and losses are determined.²

Figure 2
Schematic illustration of the simulation model used for evaluating the effect of battery size on energy consumption and charging frequency

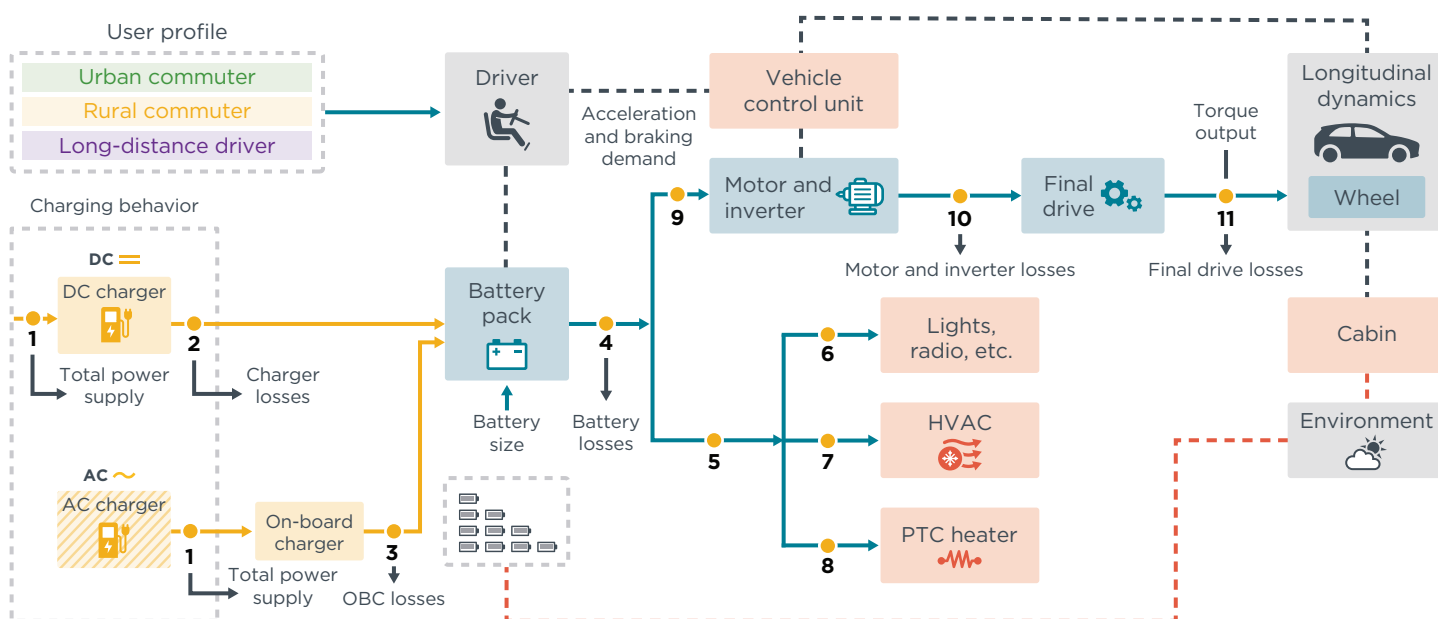

Note: Points 1-11 indicate locations where energy consumption and losses are determined.

THE INTERNATIONAL COUNCIL ON CLEAN TRANSPORTATION THEICT.ORG

The driver module receives data from the vehicle and the target speed and computes the acceleration and braking of the vehicle. To follow the target speed profile, these commands are closed-loop controlled at the vehicle control unit (VCU). The VCU takes

² The HVAC component refers to the power consumed by the heat pump compressor of the battery and cabin heating and cooling system. The power consumed by the positive temperature coefficient (PTC) heater of the HVAC system—that is a self-regulating resistance heating element whose resistances increases with temperature—is represented as a separate component. The OBC losses are the losses occurring in the on-board charger.

into account the charge-level-dependent maximum battery power, maximum motor torque at the motor speed, vehicle speed, and the forces on the vehicle, and distributes the acceleration and braking requests between the electric motor and friction brakes. Recuperated brake energy is first consumed by auxiliaries. The remaining energy is stored in the battery.

Different user profiles and charging strategies are simulated by using a state machine that selects drive cycle types depending on the time of year, the level of battery charge, and the charging strategy.

To assess the effect of peak ambient temperatures on energy consumption, and thereby on the achievable range, and to account for different usage scenarios in different months of the year, the simulation is performed with daily ambient temperature and solar irradiation profiles over the period of one year.

Key parameters derived from the simulation are average daily energy consumption, annual average real-world range, daily mileage driven, and number of AC and DC charging stops.

Details of the simulation model and how it was calibrated and verified are presented in the following sections.

2.2.1. Battery size variation

In our vehicle model, the battery capacity is varied by increasing the number of cells installed in the pack in parallel, thereby keeping the battery nominal voltage constant. Battery mass scales with capacity, increasing the total vehicle mass by the same amount, as shown in Table 2.³ Although a larger capacity also increases the battery volume, the vehicle dimensions are assumed to remain constant for comparative purposes.

Table 2

Usable battery energy and mass of different-sized batteries considered for this analysis and corresponding vehicle mass; the baseline vehicle is highlighted.

Number of cells in parallel	Usable battery energy (kWh)	Total battery energy (kWh) ^b	Battery mass (kg)	Battery volume (L)	Vehicle test mass (kg)
1	28	30.3	187	114	1,783
2	58	60.6	374	227	1,970
3	87	90.9	561	341	2,157
4	116	121.2	748	455	2,344
5 ^a	145	151.5	935	569	2,531

^a Extra simulated size used only for driver convenience analysis

^b Measured by TUM (Wassiliadis et al., 2022)

The baseline vehicle battery pack has two cells in parallel and a usable battery energy (UBE) of 58 kWh. The mass and the volume of the battery were derived from the battery pack total energy and the volumetric density values provided in the TUM report (Wassiliadis et al., 2022).

³ Note that we assume for all battery sizes the same battery pack energy density determined by TUM for the 58-kWh (UBE) battery. This assumption is supported by an analysis using the vehicle masses of the 58-kWh and the 77-kWh ID.3 models that are available in the market. Linearly extrapolating the mass to a hypothetical 87-kWh results in a very similar mass (0.5% difference) compared to obtaining the vehicle's mass by applying a constant energy density.

The smallest battery size analyzed is resized to one cell in parallel, resulting in a UBE of 28 kWh. The largest battery size simulated consists of four cells in parallel and has a UBE of 116 kWh. A model with a battery with five cells in parallel was simulated to evaluate the effect on user convenience.

Note that for the vehicle mass calculation, we did not consider that a vehicle with a heavier battery also requires a sturdier chassis, drive line, and powertrain components, which further increases the vehicle mass.

2.2.2. Electric powertrain

The main components of the vehicle's electric powertrain represented in Figure 2 are modeled to meet the vehicle's specifications and reflect their energy losses. The simulation model reflects the losses of the single-gear final drive installed between the wheels and the electric motor. The DC/AC inverter for torque control is also part of the electric motor model and is assumed to be supplied from the high-voltage battery.

Battery chemistry, as well as power and energy performance data, is used as an input into an Amesim integrated battery-sizing tool to estimate the dimensions, mass, and performance of a virtual electrochemical cell. The tool uses commercial cell data and provides open circuit voltage and resistance as a function of battery state of charge and temperature, shown in Appendix A.

In the Amesim electric motor submodel, each speed and torque combination is associated with a measured motor and inverter efficiency and calibrated with TUM data. The generated efficiency map can be found in Appendix A. Additionally, to match the battery power curves measured by TUM, we added a constant efficiency multiplier for the inverter of 96% and set a constant efficiency of 95% for the final drive. The motor-inverter assembly works in both motor and generator mode, and the same performance is considered.

To minimize charge and discharge losses, electric energy recuperated during braking is assumed to be first consumed by the auxiliaries before any remaining energy is stored in the battery. The maximum available brake power of the electric motor is dependent on the battery state of charge and temperature. The friction brakes are used only when the electric motor cannot supply the requested brake torque or when braking at a low vehicle speed.

2.2.3. Thermal management system

The thermal management system (TMS) in BEVs must not only heat and cool the passenger compartment but also control the temperature of the battery during driving and charging to ensure durability and performance. However, because electric powertrains generate little waste heat, all energy for thermal control must be generated from electricity. Therefore, the TMS is the single largest auxiliary load of a BEV and is responsible for a higher share of the total energy consumption than in conventional vehicles (Lindgren & Lund, 2016).

In our vehicle model, we incorporate a heat pump HVAC system using carbon dioxide (R744) as the working fluid, as used in the VW ID.3. The heating and cooling power is calculated as the product of the coefficient of performance (COP) multiplied by the instantaneous compressor power.⁴ The COP curves as a function of ambient

⁴ The coefficient of performance is a measure of the efficiency of a heat pump system in providing heating or cooling compared to the amount of energy input it requires. The COP of a heat pump is defined as the ratio of the amount of heating/cooling energy delivered to the amount of electrical energy consumed. A higher COP indicates greater efficiency, as more heating/cooling energy is produced for a given amount of electrical input. For example, a heat pump with a heating COP of 3 means that it produces 3 kWh of heat for every kWh of electricity consumed.

temperature are derived from Mao et al., (2023), and shown in Appendix B. To support the heat pump at very low ambient temperatures, the TMS also contains a 6-kW heating element, which is activated below a temperature threshold of 5 °C. In addition to controlling the battery temperature during driving if needed, the TMS also preheats the battery before every fast-charging event. More details on the TMS control strategy are provided in Appendix C.

For calibrating the HVAC compressor power, the battery power and temperature measurement curves from TUM tests performed at an ambient temperature of 30 °C are used. To validate the control strategy of the TMS at low temperatures, we compare the simulated energy consumption results with data presented in a recent study on real-world electric vehicle energy consumption, published by the German Federal Environment Agency (Helms et al., 2022).

The desired cabin temperature is set to 23 °C and an air recirculation rate of about 16.4% per hour is calibrated, resulting in a cabin air mass flow of 8 kg/h, in accordance with Großmann and Böttcher (2020). Heat transfer to the cabin takes into account radiative heat from solar irradiation on the vehicle surfaces, convective heat transfer from the ambient air—which is influenced by vehicle speed—as well as heat generated by the passengers, which is assumed at 100 W for 1.5 passengers.

The simulated ambient temperature and solar irradiance shown in Figure 3 are based on 2021 daily weather data for Berlin recorded by the German Weather Service (Deutscher Wetterdienst, n.d.). For the daily temperature variation, a sinusoidal temperature profile between the recorded minimum and maximum value was assumed. The solar irradiance effect is computed from time-and-date-dependent net solar irradiance in Berlin, attenuated by the cloudiness level, as available in the German Weather Service dataset.

Figure 3

Daily average temperature and solar irradiance on a horizontal surface in Berlin 2021

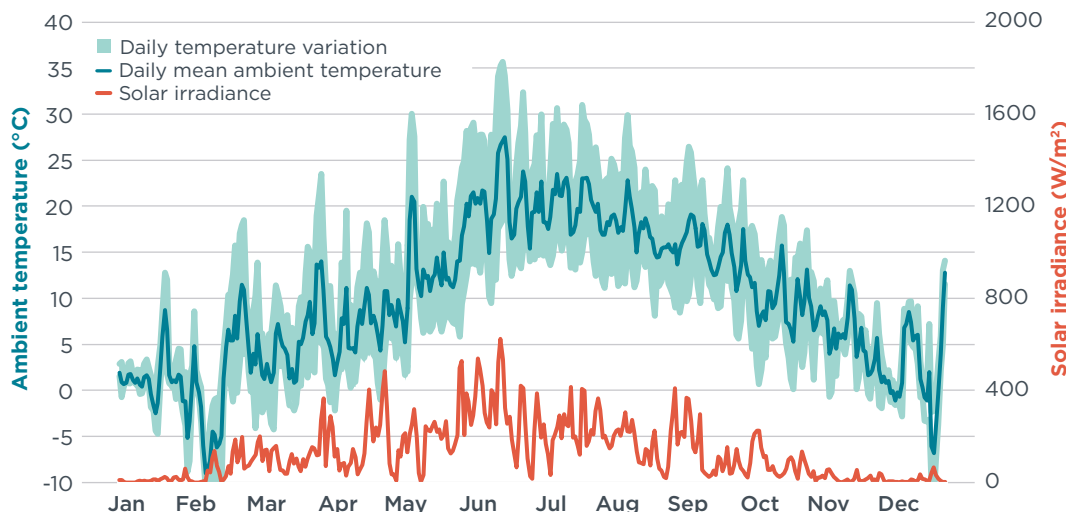

Source: Data recorded by the German Weather Service, Deutscher Wetterdienst (n.d.)

THE INTERNATIONAL COUNCIL ON CLEAN TRANSPORTATION [THEICCT.ORG](https://www.theicct.org)

2.2.4. Battery charging

Two types of charging are considered in this study: slow charging with 11 kW alternating current (AC), referred to as AC charging, and fast charging with 100 kW direct current (DC), referred to as DC charging. AC charging is limited to 43.5 kW, and DC charging is performed at power levels above 50 kW and up to 400 kW (EnBW,

2023). DC charging is associated with lower conversion losses than AC charging because DC charging bypasses the on-board AC/DC converter. The on-board charger/converter is expected to be less efficient than the stationary AC/DC converter of a charging station. However, thermal losses inside the battery increase with increased charging power, which accelerates degradation if the resulting temperature is not properly controlled.

In the simulation model, charging losses by the on-board charger and charging station are proportional to the charging power. Independent of the battery temperature and state of charge (SOC), the on-board charger losses are set to 12% while the charging station losses during DC charging are set to 4% of the instantaneous charging power. More details can be found in Appendix D. For both charging types, a constant-current/constant-voltage charging mode is implemented in the simulation model.⁵ To reduce battery degradation, charging is terminated when the SOC reaches 90% of the UBE. In the case of DC fast charging, the battery is preheated before charging starts.

2.2.5. Effect of battery aging

Battery performance degrades both over time, referred to as calendar aging, and by the number of charge cycles, referred to as cycle aging.

To assess the effect of battery aging and the related reduction in range, we conduct a simulation with a 30% battery-capacity degradation. This represents a worst-case end-of-life vehicle in line with the battery durability provisions proposed by the European Commission for the Euro 7 regulation (European Commission, 2022). As discussed in Bieker (2021), it is likely that average vehicles will show a slower degradation. The capacity degradation is implemented in the model by reducing the upper charging limit. In a conservative estimate, we assume that 70% of the UBE is used in a new vehicle that has an SOC between 20% and 90%, while 30% less energy is assumed to be available in the aged battery. Therefore, the energy available is reduced to 49% of the UBE, the upper limit is reduced to 69% to reflect this degradation, and the lower limit is kept constant at 20%.

2.3. CALIBRATION OF THE SIMULATION MODEL

The model is calibrated by adjusting the battery model parameters, the power demand of the auxiliaries, regenerative braking operating limits, and the TMS control strategy. The goal of the calibration is to match the model output data with data recorded during vehicle tests by TUM, that is instantaneous vehicle speed, electric power, battery state of charge, and battery temperature evolution, as well as total energy consumption and electric range.

Figure 4 and Figure 5 compare the simulation results of battery energy consumption and range, respectively, with data measured by TUM.⁶ The simulation results are in good agreement with the measurements, with an error range of -4.2% to 1.2% for energy consumption and -3.8% to 3.3% for the estimated electric range.

⁵ Constant current/constant voltage is a charging protocol for initially using the maximum current to charge a battery until the battery voltage reaches a threshold value. The current is then gradually reduced to keep the voltage constant.

⁶ The duration of the highway test at 30 °C performed by TUM was not long enough to provide an accurate indication of the range.

Figure 4

Simulated and measured average battery energy consumption for different drive cycles and temperatures

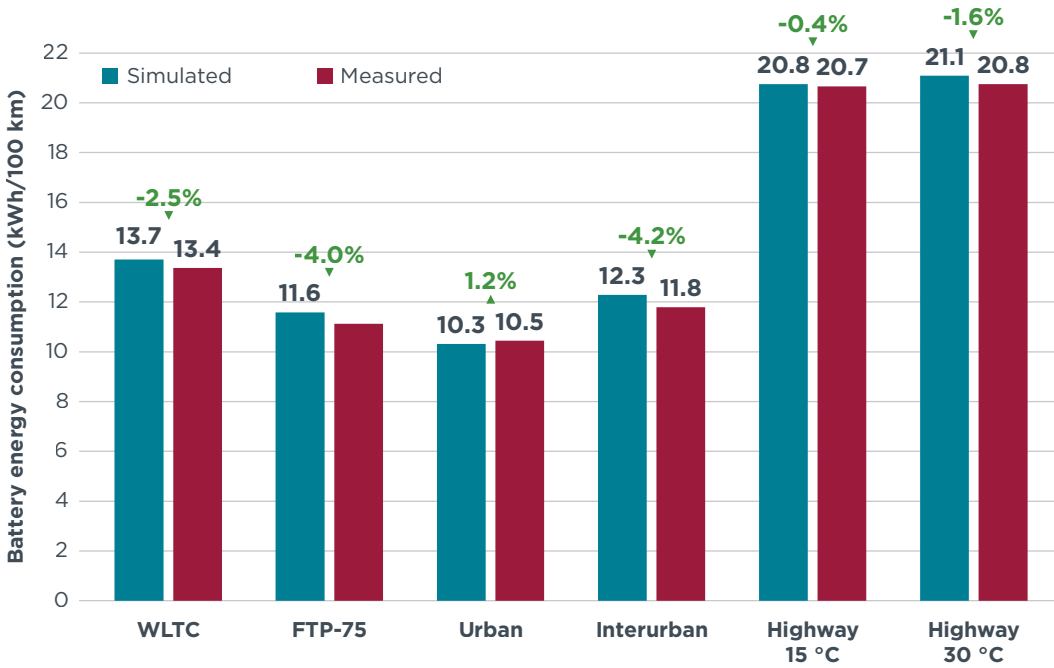

Note: Percentage values represent the error between measurement and simulation.

THE INTERNATIONAL COUNCIL ON CLEAN TRANSPORTATION THEICT.ORG

Figure 5

Simulated and measured estimated range for different drive cycles and ambient temperatures

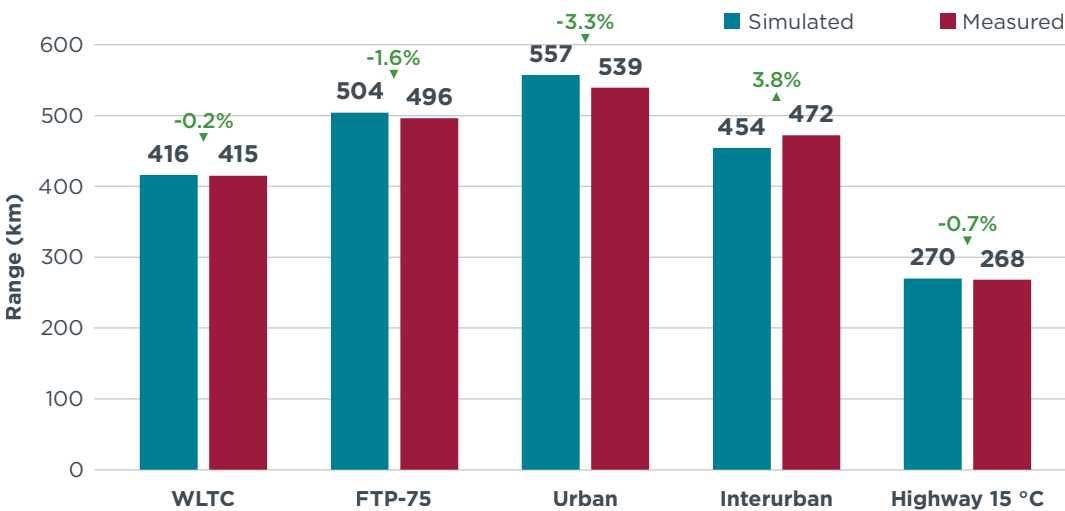

Note: Percentage values represent the error between measurement and simulation.

THE INTERNATIONAL COUNCIL ON CLEAN TRANSPORTATION THEICT.ORG

In addition to the calibration performed with the TUM data, the simulated WLTP is compared to the official reported values of the Volkswagen ID.3 reference vehicle. The results, listed in Table 3, show that the model reproduces the performance of the real vehicle accurately.

Table 3

Simulated versus reported Volkswagen ID.3 Pro performance specifications

WLTP data	Usable battery energy (kWh)	Energy consumption ^a (kWh/100km)	Vehicle consumption ^b (kWh/100km)	Range (km)	Battery mass (kg)	Charge time AC (0-100%)	Charge time DC (0-80%)	Charging losses
Simulated	57.5	15.8	13.4	429	374	6.6 h	33 min	15.6%
Reported	58 ^c	15.5–15.8 ^{c,d}	13.6–13.7 ^d	426 ^c	375 ^e	6.3 h ^c	35 min ^c	12%–13% ^d

^a Measured between charging station and vehicle including on-board charger losses for AC charging and internal charging and discharging battery losses

^b Measured at the battery outlet; corresponds to the energy used by the vehicle for propulsion and on-board systems

^c ADAC (n.d.-a)

^d EV Database (n.d.)

^e Wassiliadis et al. (2022)

2.4. SIMULATED VEHICLE USAGE SCENARIOS

The energy consumption, the number of charging stops, and the cost of charging strongly depend on the vehicle usage. Therefore, we designed multiple usage scenarios to investigate the effect of increased battery size on life-cycle GHG emissions, total cost of ownership, and user convenience (Figure 6). Details of the scenarios' design variables are presented in the following sections.

Figure 6

Design variables for the vehicle usage scenarios

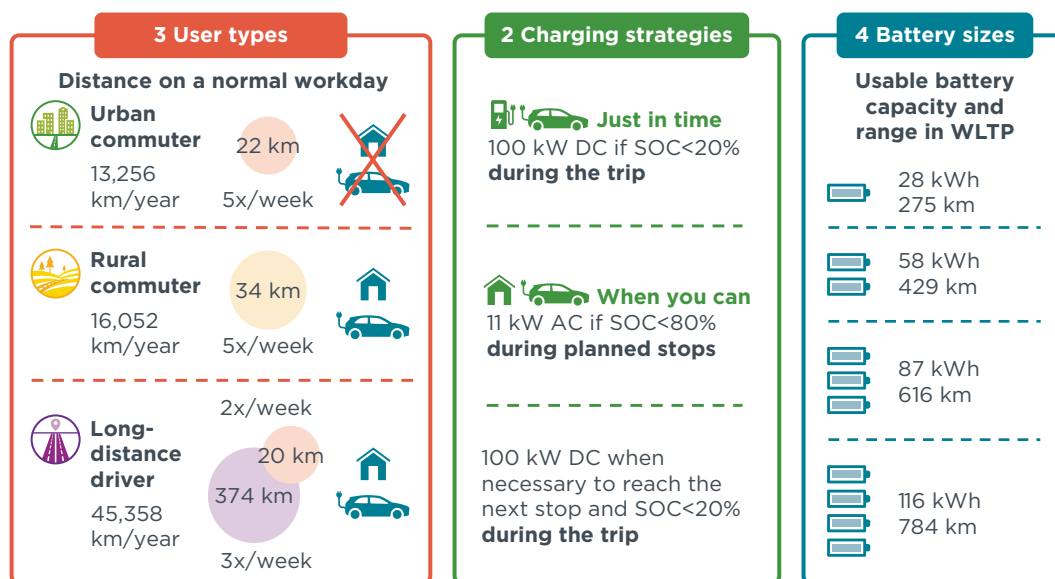

THE INTERNATIONAL COUNCIL ON CLEAN TRANSPORTATION [THEICCT.ORG](https://www.theicct.org)

2.4.1. User types

Three generic user types are defined to resemble the vehicle usage patterns of urban and rural commuters as well as of frequent long-distance drivers. The user types differ in their speed profiles, trip distances, and number of trips per day and week.

The user types also differ in access to charging options. The urban commuter is assumed to live in an apartment building without access to home charging, and therefore all charging is either performed at work or at public charging stations. The rural commuter is assumed to live in a detached house and recharge at home whenever

the SOC is below 80%, independent of the charging strategy. Furthermore, the vehicle is preheated using grid energy before leaving the house in the morning. Given the lower need for public charging, it is assumed that the rural commuter does not have a monthly subscription for public charging stations, and therefore pays ad hoc charging prices when away from home. The long-distance driver is assumed to have access to overnight home charging and preheats the vehicle using grid energy before leaving in the morning. However, the long-distance driver is expected to charge frequently along the route and is, therefore, assumed to have a monthly subscription for public charging.

The annual driving profiles driven by the different user types over the course of one year are adjusted to match the average annual distances reported in literature. Using the Mobility in Germany report as reference (Bundesministerium für Digitales und Verkehr, 2017), the simulated annual mileage is 13,256 km for the urban commuter and 16,025 km for the rural commuter. For the long-distance driver, we opted to represent a user on the upper-end limit of this category. While Bundesanstalt für Straßenwesen (2017) reports the average mileage for company cars was 24,519 km per year in 2017, a survey by Arval Mobility Observatory of companies with vehicle fleets indicates that around 25% of company cars were driven more than 40,000 km in 2022 (Arval Mobility Observatory, 2022). To model a user with very high but still representative annual mileage, we composed a profile for a long-distance driver who travels a total of 45,358 km per year, which is 1.85 times higher than the average company car mileage.

The annual driving profiles of the three user types are composed from different driving-day types, as shown in Table 4. For composing the day-type trips, the speed profiles of the urban, rural, and motorway sections of the Common Artemis Driving Cycle 130 are utilized.⁷ More details on the drive cycles used can be found in Appendix E. While the speed profiles on commute days are considered different for the three user types, the leisure and non-work short-distance trips are assumed to be the same.

Table 4
Driving-day types used to compose the annual vehicle usage profiles of the three user types

Day type	Driven by user type	Trips per day	Day type frequency	Daily distance	Reflected by drive cycle
Urban commute	Urban commuter	2	5 days/week	22 km	Artemis Urban
Rural commute	Rural commuter	2	5 days/week	34 km	Artemis Rural and Artemis Urban
Highway commute	Long-distance driver	1	3 days/week	374 km	Artemis Motorway 130
Leisure medium-distance trip	Urban commuter Rural commuter Long-distance driver	1	30 days/year	30 km	Artemis Motorway 130
Leisure long-distance trip	Urban commuter Rural commuter Long-distance driver	1	7 days/year	750 km	Artemis Motorway 130
Non-work short-distance trip	Urban commuter Rural commuter Long-distance driver	2	84 days/year 84 days/year 225 days/year	20 km	Artemis Urban
No driving	Urban commuter Rural commuter Long-distance driver	—	Remaining days	—	—

⁷ For more information, see TransportPolicy.Net. (n.d.).

Figure 7 shows the composition of the monthly vehicle usage profile by number of driving-day types and the corresponding mileage for each user type. The long-distance leisure trips, such as for vacation, are set to occur in January, June, October, and December to represent cold, hot, and moderate conditions. In these months, days with medium-distance trips and days with no driving are considered as well. Additional medium-distance trips are assumed to also occur in February, May, September, and November.

Figure 7
Monthly driving profile composition by number of day-types and resulting monthly distances driven for the three user types

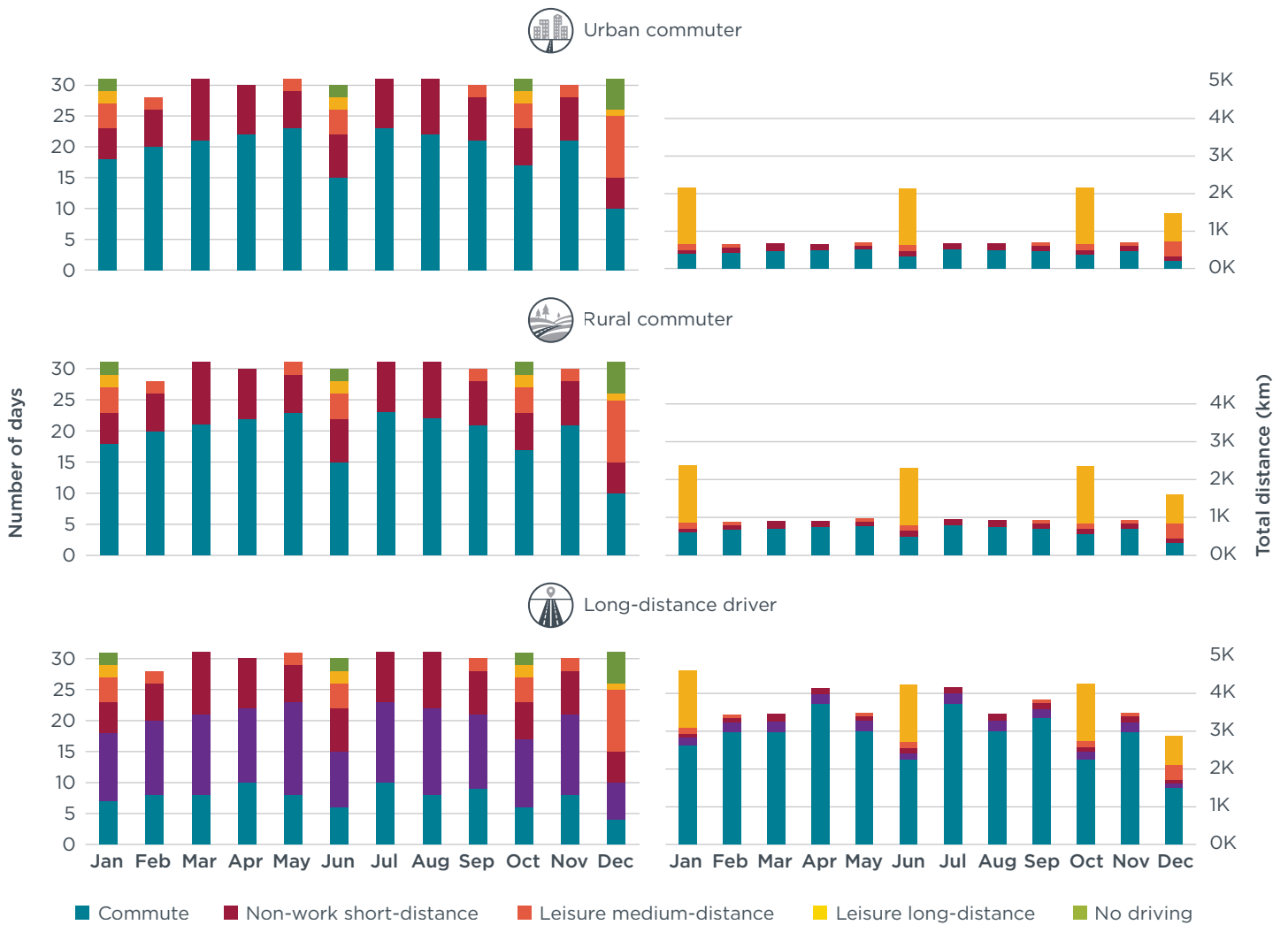

THE INTERNATIONAL COUNCIL ON CLEAN TRANSPORTATION THEICCT.ORG

2.4.2. Battery charging strategies

Two charging strategies are simulated for each user type, as summarized in Table 5.

Table 5
Charging strategies

Charging strategy	AC charging (11 kW)	DC charging (100 kW)
When-you-can	<ul style="list-style-type: none">• During all planned stops if SOC < 80%• Rural commuter and long-distance driver also charge at home if SOC < 80%	During the trip if SOC < 20% and if distance to the next stop is longer than remaining range
Just-in-time	Rural commuter and long-distance driver charge at home if SOC < 80%	During the trip if SOC < 20%

In the when-you-can scenario, the driver utilizes AC charging during all planned stops if the SOC is lower than 80%. If the SOC drops below 20% during driving and the distance to the next stop is higher than the remaining battery range, the battery is replenished by DC charging.

In the just-in-time scenario, the battery is recharged by DC charging when the SOC drops below 20%. Additionally, AC home charging is performed by the rural commuter and the long-distance driver if the SOC is below 80% when reaching home.

2.5. HOW SIMULATION RESULTS ARE USED TO ASSESS THE EFFECTS OF BATTERY SIZE

Based on the simulation results, the effect of the battery size on life-cycle GHG emissions, total cost of ownership, and user convenience are assessed. The main simulation output parameters used for this analysis are the total energy consumption, including charging losses in kWh per 100 km, and the number of en-route charges. En-route charges are DC charges performed during trips due to a drained battery. The following sections describe the applied methodology for our analyses.

2.5.1. Methodology for assessing life-cycle greenhouse gas emissions

Life-cycle GHG emissions are estimated using the life-cycle assessment methodology described in a previous ICCT study (Bieker, 2021). It considers the 100-year global warming potential of GHG emissions in grams of CO₂-equivalent (gCO₂eq) per kilometer driven over the lifetime of a vehicle. The assessment covers GHG emissions correlating to the production of electricity consumed during the vehicle's use phase. It also covers emissions related to the vehicle cycle such as battery production, which includes raw material extraction and processing, maintenance, and recycling. Maintenance includes emissions associated with consumables and spare parts replaced during the vehicle's lifetime. In this section, we will focus only on the life-cycle assessment parameters affected by changes in battery size.

2.5.2. Vehicle production emissions

Battery production emissions are estimated by assuming a carbon intensity of 54 kilograms of CO₂-eq per kWh of total battery capacity, corresponding to the average emissions of producing lithium-ion batteries with an NMC622-graphite cathode chemistry in Europe (Bieker, 2021). The production GHG emissions for the investigated battery sizes are then estimated by multiplying the carbon intensity by the total battery capacity.

For emissions from vehicle production excluding the battery, we refer to the data for the compact segment vehicles in European Commission, Directorate General for

Climate Action (2020) which is also the source used in Bieker (2021). On this basis, we consider a vehicle production emission factor of 5.3 tons CO₂-eq per ton of vehicle mass. The vehicle mass excluding the battery is assumed to remain constant for all battery sizes, and therefore so are the associated GHG emissions.

2.5.3. Electric energy production emissions

To calculate the use-phase emissions of the vehicle, we assume a lifetime mileage of 245,000 km for all use cases, as in Bieker (2021). The lifetime in years is estimated by assuming a constant lifetime mileage and dividing it by the annual mileage of each user. Table 6 summarizes the average annual mileage driven for each user type, the resulting vehicle lifetime, and the weighted average GHG intensity of grid electricity.

Table 6
Parameters used for determining life-cycle greenhouse gas emissions from the production of electricity consumed during driving over a vehicle’s lifetime

User type	Average annual mileage over lifetime (km)	Vehicle lifetime (years)	Average GHG intensity of grid electricity (gCO ₂ -eq/kWh)
Urban commuter	13,256	18.5	181.8
Rural commuter	16,052	15.3	212.7
Long-distance driver	45,358	5.4	341.2

Note: The lifetime values shown represent a theoretical lifetime. Because average annual mileage decreases over a vehicle’s lifetime, and because the usual first owner of a company car holds it for 1 to 3 years, the real vehicle lifetime is expected to be higher, especially in the case of the long-distance driver.

The projections of GHG intensity for grid electricity in Germany are taken from Bieker et al. (2022). These values are based on the electricity mix of the Climate Neutral 2045 scenario by Prognos et al. (2021) and the Intergovernmental Panel for Climate Change’s global median life-cycle carbon intensity factors for electricity generation (Moomaw et al., 2011), corrected for transmission and distribution losses. With the assumed vehicle lifetimes of 18.5 years for urban commuters, 15.3 years for rural commuters, and 5.4 years for long-distance drivers, this study considers the average electricity mix of the years 2023–2041, 2023–2037, and 2023–2027, respectively. As the carbon intensity of the German electricity mix is expected to decrease over time, this means that the lifetime average GHG intensity of grid electricity used by the long-distance driver is higher than for the other two users.

2.5.4. Methodology for estimating 4-year total cost of ownership

The total cost of ownership (TCO) is estimated for the first owner of the vehicle assuming a 4-year holding period from the beginning of 2023 to the end of 2026. Cost components considered include the vehicle base price as a function of battery size, resale price, value-added tax (VAT), cost of consumed electricity, maintenance, insurance, home charger installation, and the greenhouse gas quota. The German electric-vehicle purchase subsidy is disregarded given its phase-out starting in 2024 (ADAC, 2024). Costs are estimated based on publicly available figures for Germany. In the following sections, the cost components affected mostly by the variation in battery

size are described. The assumptions made for other TCO components considered in this analysis can be found in Appendix F.

2.5.5. Battery cost

A substantial part of the vehicle purchase price relates to the battery cost. To estimate how the vehicle purchase price changes with increased battery size, we consider the cost difference between the ID.3 Pro Performance with a 58-kWh battery pack and a 77-kWh battery pack. We used the vehicle price comparator tool of the German car club ADAC (ADAC, 2021), which estimates the price of different vehicle models with the same auxiliary equipment. The cost difference between the two models is assumed to correspond to the battery pack cost difference, which is used to estimate the battery cost in euros per kilowatt-hour. This results in a total battery cost of €203 per kilowatt-hour of total battery capacity for the ID.3 and a base vehicle price of €20,928, excluding the battery and the value-added tax.⁸

2.5.6. Electricity price

The electricity prices used in this study differ by charging location and user type. For home AC charging, which is assumed to be available only to the rural commuter and the long-distance driver, we assume a cost of €0.302/kWh based on the 2022 average rate for household electricity in Germany (Eurostat, 2022). Given the high uncertainty of electricity price development due to the war in Ukraine and the renewable energy transition, we assume that household electricity prices remain constant over the 4-year holding period. In addition to electricity cost, we account for the proportionate cost of home charger installation; details can be found in Appendix F.

Prices for public charging are based on the European Alternative Fuels Observatory charging price calculator (European Alternative Fuels Observatory, 2022). Public AC charging is expected to cost €0.49/kWh under a monthly subscription with an e-mobility service provider, as assumed for the urban commuter and the long-distance driver. Without a subscription, the price is €0.56/kWh, assumed to be paid by the rural driver.

Public DC charging is performed by all user types during en-route stops to minimize charging time. For user types with an e-mobility service provider subscription (urban commuter and long-distance driver), the price is €0.59/kWh. Without a subscription, the rural commuter pays the ad hoc charging price, which is expected to be €0.70/kWh. Table 7 summarizes the charging rates considered.

Table 7
Electricity charging rates in euros per kilowatt-hour

Home charging	Public AC charging with subscription	Public AC charging without subscription	Public DC charging with subscription	Public DC charging without subscription
€0.30/kWh	€0.49/kWh	€0.56/kWh	€0.59/kWh	€0.70/kWh

2.5.7. Assessing user convenience

For this study, we evaluate user convenience in terms of the number of en-route stops for charging. This metric entails two underlying assumptions: first, charging that takes

⁸ This estimate aligns well with the cost derived from a BloombergNEF market analysis (BloombergNEF, 2022). The battery pack prices estimated by BloombergNEF corresponds to €131.1/kWh on a volume-weighted average basis in 2022, considering an exchange rate of 0.95 from U.S. dollar to Euro. To account for indirect costs charged by the vehicle manufacturer, we add a cost multiplier of 1.56, as estimated in a previous ICCT publication (Dornoff et al., 2022). This results in €204.5/kWh, 0.8% higher than our assumption based on the ID.3 specific cost analysis.

place at home or work is considered convenient; and second, a fast-charging station is available whenever recharging is necessary.

In addition to analyzing the average number of charging stops over one year, we also assess this parameter for each trip day-type and for each month, considering the monthly variability in distances driven as well as the effect of ambient conditions.

3. ANALYSIS RESULTS

Applying the methodology described in the previous section, the simulation model provides detailed information on the effect of an increasing battery size on energy consumption and the number of charges required for the three defined user types. In this section, we present the simulation results and the derived effects on user convenience, life-cycle GHG emissions, and total cost of vehicle ownership. Additionally, we compare the user-convenience results of a new battery with the results of the same tests performed with an aged battery.

3.1. ANNUAL AVERAGE ENERGY CONSUMPTION

Annual average energy consumption is used to estimate the life-cycle GHG emissions and the total cost of ownership. Consumption is determined by dividing the total amount of grid energy consumed over one year, including the energy used for preheating the battery, by the distance driven.

For a 58-kWh battery, which is used in the ID.3 BEV, the simulated average annual energy consumption is between 19.9 kWh/100km for the rural driver and 22.2 kWh/100km for the long-distance driver. Compared to the average real-world energy consumption value of 19.3 kWh/100km reported by consumers on the website [spritmonitor.de](https://www.spritmonitor.de) for the same vehicle, the simulated consumption values are slightly higher. However, it is unclear whether the [spritmonitor.de](https://www.spritmonitor.de) entries consider charging losses and therefore underestimate the true grid energy consumption. For this reason, Helms et al. (2022) assume the grid energy consumption to be about 10% higher than the [spritmonitor.de](https://www.spritmonitor.de) reported values. Applying the same assumption, the adjusted consumer-reported energy consumption of 21.2 kWh/100km is within the simulated range. Compared to the official type-approval energy consumption of 15.4 kWh/100km, the simulated real-world energy consumption is between 29% and 44% higher for the three user types.

Figure 8 shows on the left axis the effect of increasing battery size on the annual average energy consumption for each user type, depending on the charging strategy applied. On the right axis, the number of en-route charging events is displayed for the same scenarios.

Figure 8

Annual average energy consumption and number of en-route charge stops per year by battery size

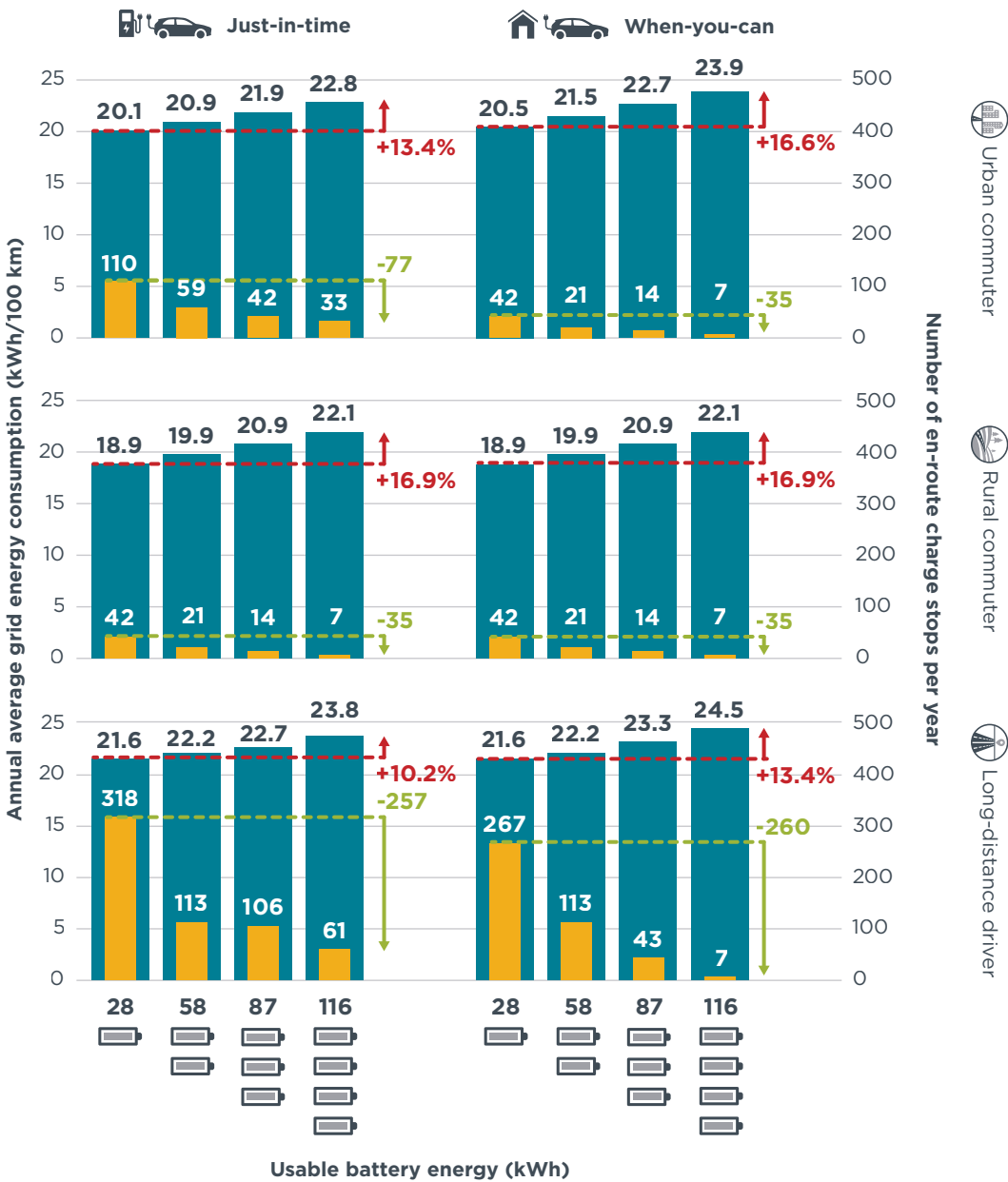

THE INTERNATIONAL COUNCIL ON CLEAN TRANSPORTATION [THEICCT.ORG](https://www.theicct.org)

For all user types, the vehicle consumes more energy with increasing battery capacity, while the number of en-route charges decreases. In all scenarios, the when-you-can charging strategy leads to the same or higher energy consumption than the just-in-time strategy. For the rural commuter, both charging strategies result in the same charging pattern and, therefore, lead to the same energy consumption and number of en-route charge stops.

The effect of increasing battery size on energy consumption is most pronounced for the urban commuter applying the when-you-can charging strategy, increasing by 16.6% from 20.5 kWh/100km with a 28-kWh battery to 23.9 kWh/100km with a 116-kWh battery.

The absolute decrease in the number of en-route charging stops is most pronounced when increasing the battery size from 28 kWh to 58 kWh for all user types. For the

long-distance driver, a further increase in battery size leads to a substantial reduction in the number of charging stops.

When the when-you-can charging strategy is applied, the number of en-route charging stops is minimized compared to the just-in-time strategy, as expected. However, this decrease in charging stops comes with higher average energy consumption.

To better understand the observed effects of the charging strategy and battery size on energy consumption, the following section analyses the energy consumption by vehicle component.

3.2. BREAKDOWN OF AVERAGE ENERGY CONSUMPTION BY VEHICLE COMPONENT

To derive which components are most affected by changes in charging strategy and battery size, and thereby contribute most to the average grid-energy consumption, the energy consumption and energy losses of the following drivetrain components are investigated:

- » driving energy demand at the wheel, divided into aerodynamic drag, rolling resistance, and acceleration energy;
- » brake energy recuperated;
- » energy consumed by the thermal management system, split by battery and cabin HVAC;
- » energy consumption of low-voltage auxiliaries; and
- » mechanical and thermal losses at the charging station, on-board charger, final drive, battery, inverter, and motor.

3.2.1. Higher energy consumption with the when-you-can charging strategy

As discussed in the previous section, the annual average energy consumption is higher for the when-you-can than for the just-in-time charging strategy. To analyze this in more detail, Figure 9 shows the energy consumption by component—comparing the just-in-time and when-you-can charging strategies (rows) for two different battery sizes (columns)—for the urban commuter.

Figure 9

Effect of charging strategy on energy consumption by component for the 58 kWh and 116 kWh battery for the urban commuter

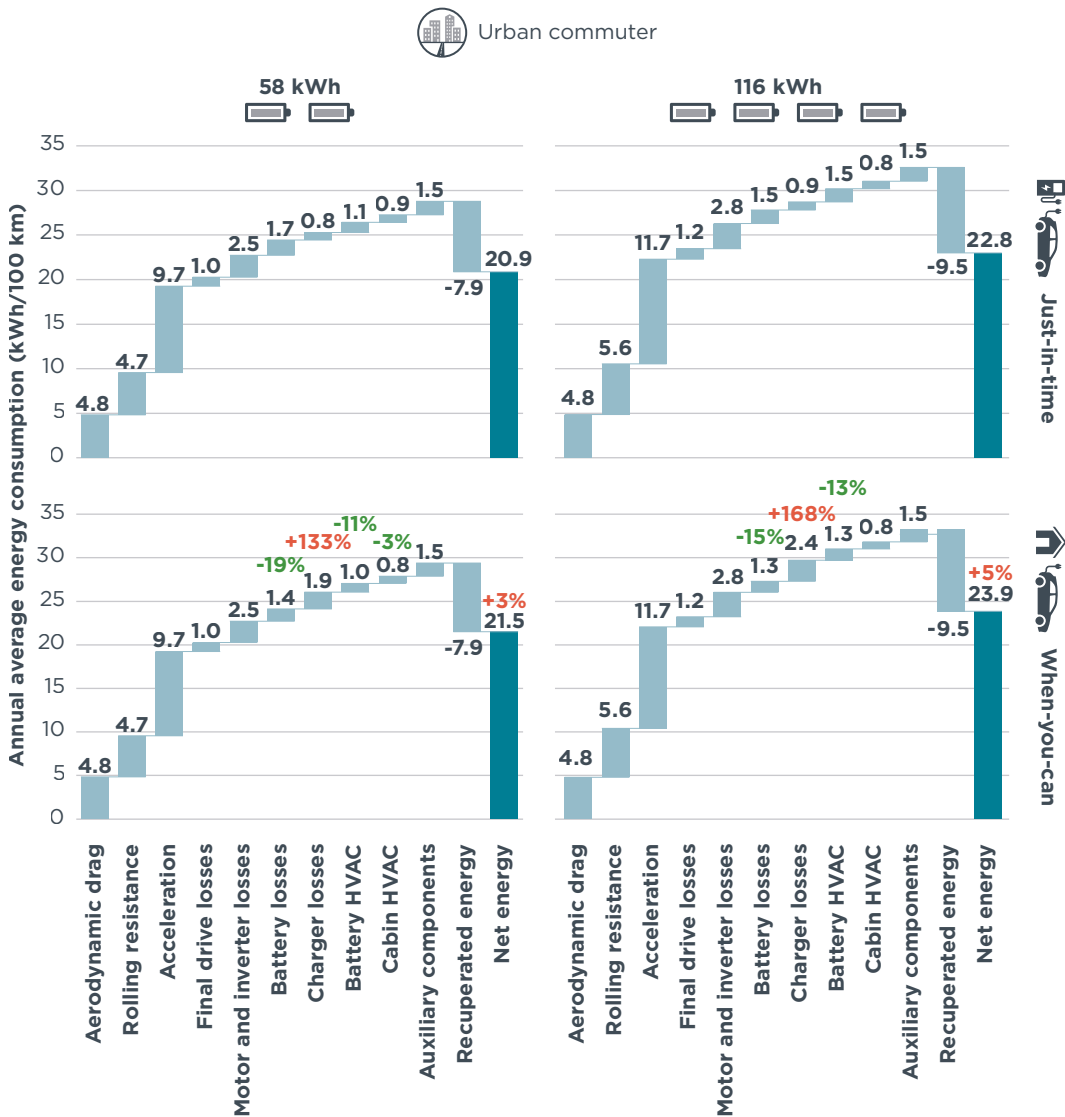

Note: Battery losses refer to the internal battery charging and discharging. Charger losses correspond to the external charger during DC charging and the on-board charger during AC charging.

THE INTERNATIONAL COUNCIL ON CLEAN TRANSPORTATION [THEICCT.ORG](https://theicct.org)

The higher number of DC fast charging events that occur with the just-in-time strategy requires more frequent temperature conditioning of the battery. Therefore, the energy consumption of the battery HVAC system when applying the when-you-can strategy is 11% lower for the 58-kWh battery and 13% lower for the 116-kWh battery. Furthermore, the lower charging power associated with the when-you-can strategy also reduces the losses inside the battery by 19% for the 58-kWh battery and by 15% for the 116-kWh battery. However, using the less efficient on-board charger increases the average charger losses for the 58-kWh battery by 1.1 kWh/100km, or 133%, and for the 116-kWh battery by 1.5 kWh/100km, or 168%. This leads to a higher net energy consumption for the when-you-can strategy of 0.6 kWh/100 km, or 3%, in the case of the 58-kWh battery compared to the just-in-time charging strategy. The effect is more pronounced for the vehicle with the 116-kWh battery due to higher absolute energy consumption, resulting in 5% higher energy consumption for the when-you-can strategy, or 1.1 kWh/100km in absolute numbers. Aerodynamic, rolling resistance, acceleration

energy demand, recuperated brake energy, and losses in the final drive, motor, and inverter are not affected by the charging strategy.

Regardless of the lower efficiency of the when-you-can strategy we consider it to be more realistic for real-world use, as it better addresses consumer range anxiety and considerably improves convenience by minimizing the number of en-route charging stops. Therefore, we present from here on only results for the when-you-can strategy.

3.2.2. Increase in energy consumption with battery size

For all user types, a larger battery is associated with higher energy consumption. To assess which components are driving this increase, Figure 10 shows the annual average energy consumption by component when increasing the usable battery energy from 58 kWh (upper row) to 116 kWh (lower row). The left column reflects the impact on the urban commuter, and the right column shows the long-distance driver. In both cases, the when-you-can charging strategy is used.

Figure 10
Effect of increasing battery size from 58 kWh to 116 kWh on energy consumption by component for the urban commuter and long-distance driver

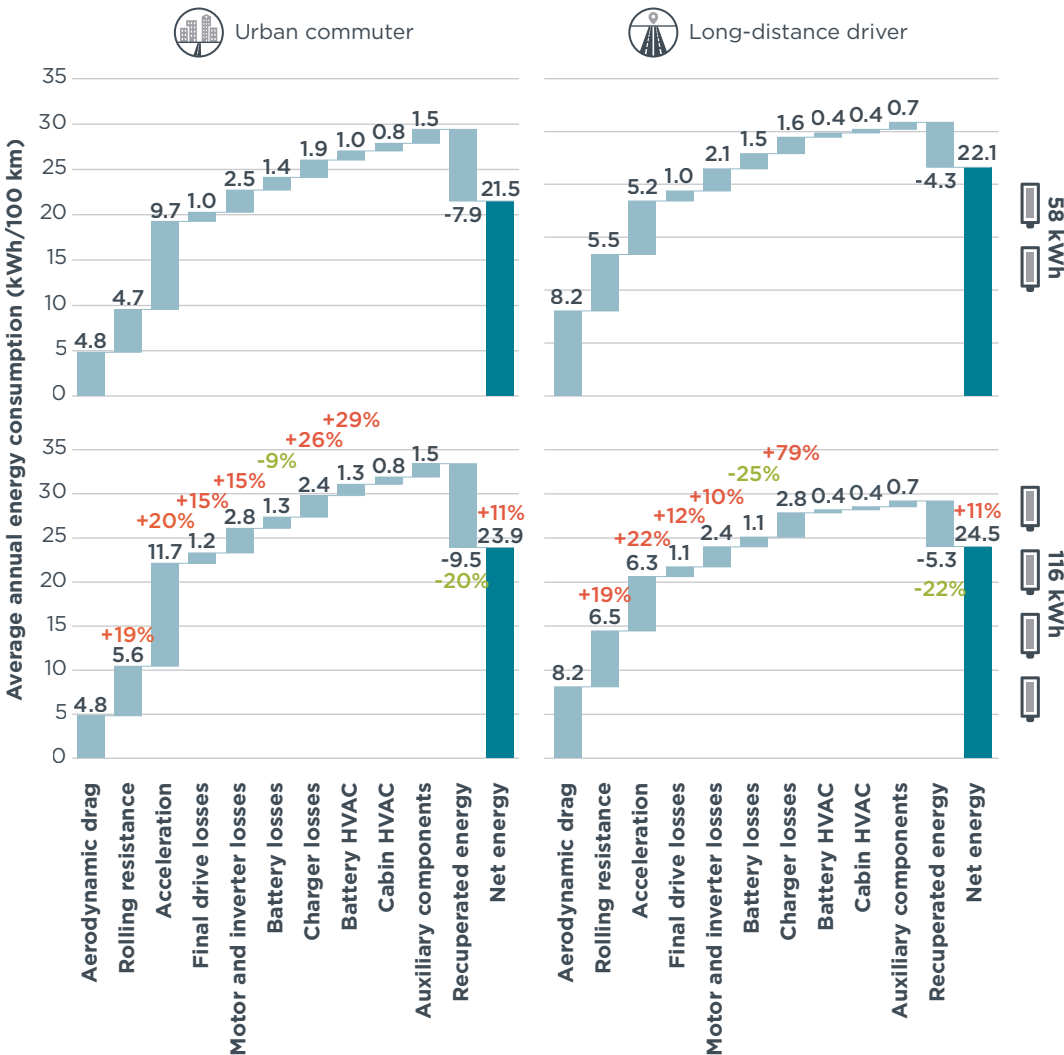

Note: Battery HVAC and cabin HVAC refer to the energy consumed by the thermal management systems for the battery and the passenger compartment. Auxiliary components refers to lights, windows, radio, etc.

Increasing the battery size from 58 kWh to 116 kWh, and thereby the vehicle mass, increases the rolling resistance by 19% for both the urban commuter and long-distance driver. The acceleration energy demand increases by 20% for the urban commuter and by 22% for the long-distance driver. Therefore, the larger battery has higher total driving energy demand—that is, the sum of the aerodynamic drag, rolling resistance, and acceleration energy components—of 2.9 kWh/100km (15%) for the urban commuter and 2.1 kWh/100km (11%) for the long-distance driver. Although a substantial share of the acceleration energy can be recuperated during braking, net energy demand increases by 1.3 kWh/100km, or 11%, for the urban commuter and by 1.1 kWh/100km, or 7.5%, for the long-distance driver.

Furthermore, because the total energy transferred to and within the vehicle with the larger battery is higher, the losses in the powertrain increase. In the case of the urban commuter, losses in the final drive, motor, and inverter increase by 0.5 kWh/100km, or 14%, and for the long-distance driver by 0.4 kWh/100km, or 13%.

With increasing battery size, fewer en-route DC charging stops are required, so a larger share of the total energy is charged using AC charging. Therefore, associated on-board charger losses increase with the larger battery. Improvements in battery losses due to more AC charging cannot outweigh the increase in charger losses and, therefore, net charging losses are higher for the larger battery. For the urban commuter, the charger losses for the 116-kWh battery—compared to the 58-kWh battery—increase by 0.5 kWh/100km, while the battery losses decrease by 0.1 kWh/100km, resulting in a total increase of 0.4 kWh/100km, or 11% higher losses. For the long-distance driver, the charger losses increase by 1.2 kWh/100km for the 116-kWh battery, while the battery losses decrease by 0.4 kWh/100km, resulting in a total increase of 0.9 kWh/100km, or 29% higher losses.

The higher thermal mass of the larger battery requires more energy for preheating, increasing the energy consumption of the HVAC system by 0.3 kWh/100km for the urban commuter.

In total, the combination of higher driving energy demand and higher energy losses for the larger 116kWh battery increases the annual average energy consumption by 2.4 kWh/100km, or 11%, for both the urban commuter and the long-distance driver.

3.3. EFFECTS OF USER BEHAVIOR AND AMBIENT CONDITIONS ON ENERGY CONSUMPTION

Whereas the annual average energy consumption of BEVs affects the life-cycle GHG emissions and ownership cost, the variability in energy consumption, and thereby available range, caused by differences in ambient conditions and vehicle usage influences user convenience most.

Figure 11 presents, over the course of one year, the monthly grid energy consumption, available range, TMS energy consumption, distance driven, and temperature for the urban commuter on the left and the long-distance driver on the right. Given the similarity of the results for the urban and rural commuters, the latter is not shown to reduce complexity.

Figure 11

Monthly energy consumption and estimated range by battery size using the when-you-can charging strategy

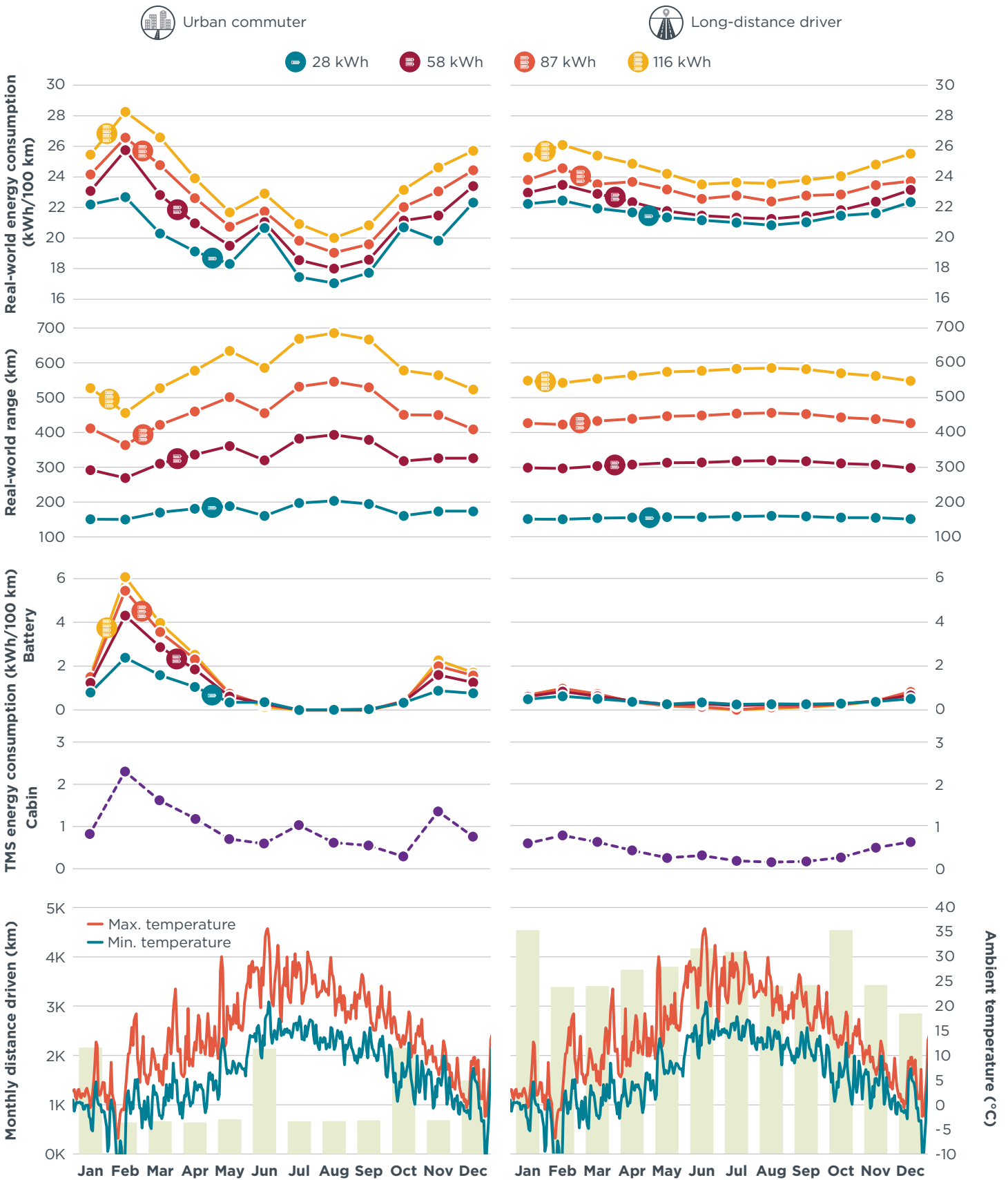

Note: The energy consumption of cabin and battery thermal management systems is shown separately.

THE INTERNATIONAL COUNCIL ON CLEAN TRANSPORTATION THEICT.ORG

The TMS total energy consumption varies month-to-month, depending on the ambient temperature and the distance driven. The month with the lowest TMS energy consumption is June and TMS energy demand peaks in February when ambient temperatures are lowest.

The energy-consumption results by month show that different users have different sensitivities to using the TMS. Energy consumption by the urban commuter varies more with the ambient temperature, while the long-distance driver's energy consumption related to the TMS remains almost constant during the year. Moreover, the urban commuter's variability in energy consumption is more pronounced with the larger battery due to the higher TMS energy demand. In July, when temperatures are above average and the distance driven is low, energy consumption for the urban commuter is 17.5 kWh/100km with the 28-kWh battery and 20.9 kWh/100km with the 116-kWh battery, corresponding to a 20% consumption increase with the larger battery. For the long-distance driver, the energy consumption in July is 21.0 kWh/100km with a 28-kWh battery and 23.6 kWh/100km with a 116-kWh battery, corresponding to a 12% increase using the larger battery.

Given that the average trip distance is lower for the urban user, the TMS operation in transient mode—that is the initial cooling or heating needed to reach the target temperature—represents a higher fraction of the total driving time. Due to the high energy consumption associated with the transient mode, the TMS has a higher impact on the monthly variability of energy consumption for this user. Moreover, the monthly differences in distances driven—between months with long-distance leisure trips and months where only regular commutes take place—is much larger for the urban commuter than for the long-distance driver. Therefore, the urban commuter shows a larger variability in TMS energy consumption between months with similar ambient temperatures but with different driving profiles than the long-distance driver.

Consequently, the available range is more sensitive to ambient temperature variations for the urban driver than for the long-distance driver. The estimated range for the urban commuter using a 58-kWh battery varies from 393 km in August to 269 km in February, a decrease in range of 32% or 124 km. The urban commuter using a 116-kWh battery has a range of 686 km in August and 457 km in February, corresponding to a range reduction of 229 km. For the long-distance driver, the range varies from 319 km in August to 296 km in February, that is 23 km less with the 58-kWh battery. The long-distance driver's range drops by 43 km from 585 km in August to 542 km in February with the 116-kWh battery.

3.4. HOW BATTERY SIZE AFFECTS THE NUMBER OF EN-ROUTE CHARGING STOPS AS A METRIC FOR USER CONVENIENCE

We assess the effect of the battery size on user convenience in terms of the number of en-route charge stops per day and over the year.

Figure 12 shows that for the urban commuter, en-route charge stops are only necessary in the months where long-distance trips are performed, that is in January, June, October, and December. During these months, the urban commuter performs six en-route charging stops with the 58-kWh battery and two en-route stops with the 116-kWh battery (-66%). The long-distance driver benefits more from increased battery size due to the high monthly mileage throughout the year and the related high number of en-route charging events in each month. With the 58-kWh battery, the driver has to make between 8 and 13 en-route charge stops per month, while with the 116-kWh battery no en-route charge stops are required during a normal commute month. For the urban commuter, the 116-kWh battery reduces the number of en-route charge stops to two in months where long-distance leisure trips take place.

Figure 12

Number of en-route charge stops per month using the when-you-can charging strategy

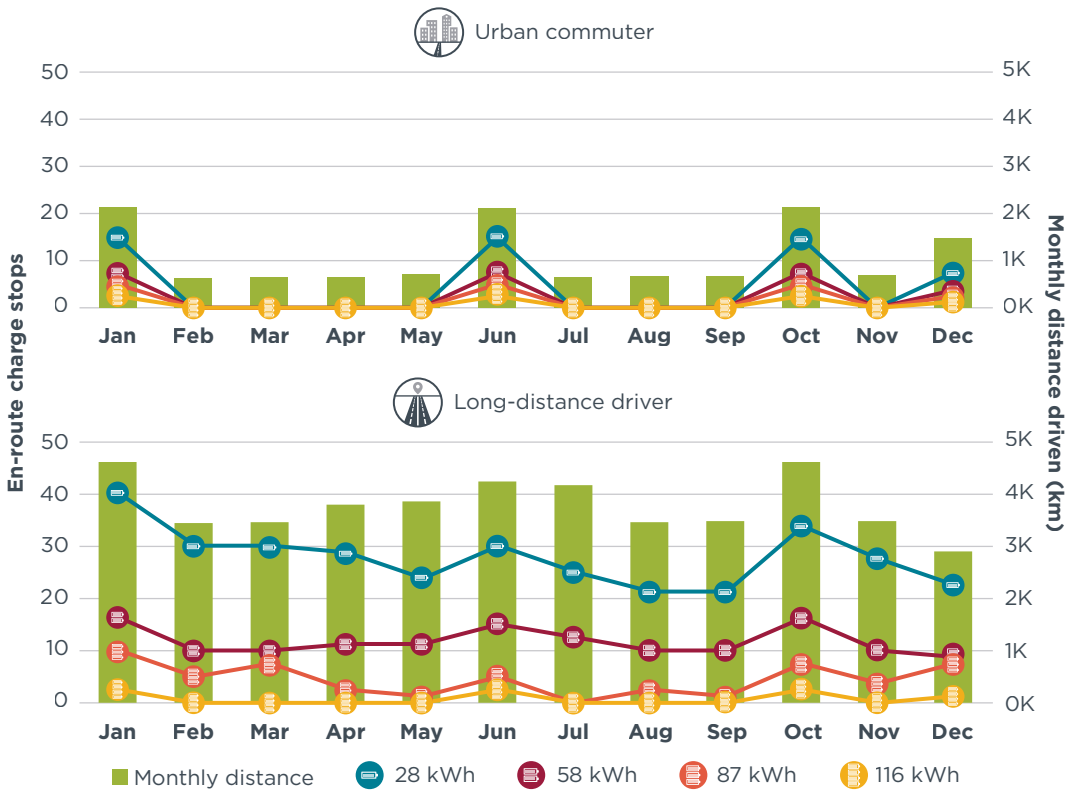

THE INTERNATIONAL COUNCIL ON CLEAN TRANSPORTATION THEICT.ORG

Figure 13 shows the average number of DC charges per day when considering all days of the year (left), as well as when only considering commute days (center) and long-distance trip days (right). To more comprehensively assess the trend, we simulated a fifth battery size with a usable capacity of 145 kWh.

Figure 13

Annual average number of en-route charging stops per day as a function of usable battery energy, assuming a when-you-can charging strategy

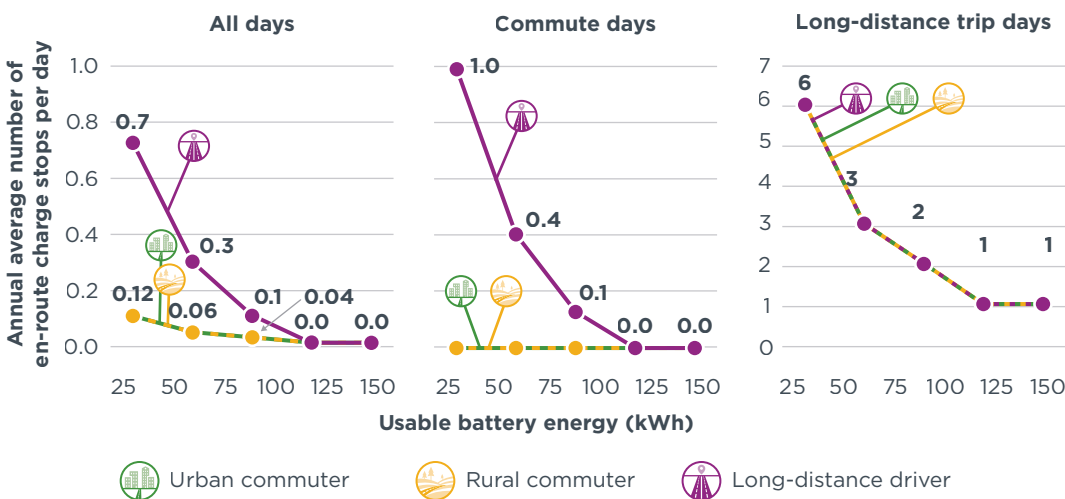

THE INTERNATIONAL COUNCIL ON CLEAN TRANSPORTATION THEICT.ORG

For the urban and rural commuter, when considering all days, increasing the battery capacity from the smallest 28-kWh battery to a 116-kWh battery leads to a reduction in charge stops of less than 0.2 per day. The reduction is mostly caused by the lower

number of charges during long-distance leisure trip days, which represent a very small percentage of total days in the year.

For the long-distance driver, the effect of an increased battery size on the annual average en-route charge stops is more pronounced due to the higher energy demand of the commute day, which accounts for the highest share of day types throughout the year (92 out of 365). Increasing the battery size can reduce the number of en-route charge stops on commute days to zero for this user type. However, beyond a battery size of about 120 kWh, the number of en-route charge stops does not decrease further as the traveled distance is shorter than the average range enabled by the battery.

Since the long-distance trip-day driving profile is the same for all users, the reduction in charge stops from three for the 58-kWh battery to one for batteries larger than 116 kWh (-66%) can be observed for all users.

3.4.1. Effect of an aged battery on the number of en-route charges

An aged battery is associated with a lower usable battery energy, and thereby a lower range, which can affect the number of required en-route charge stops. To assess the effect of an aged battery on user convenience, Figure 14 compares the number of en-route charges per day required with a new and an aged battery. The results for the urban commuter (left column) and the long-distance driver (right) are shown. The top row shows the average annual number of en-route charge stops when considering all day-types and the lower row when accounting for only commute days. When considering all day-types, there is a minimal increase in the number of charge stops for the aged battery, with the largest increase of 0.16 stops per day occurring for the long-distance driver with a 28-kWh battery. The number of charge stops due to battery aging increases on commute days only in the case of the long-distance driver, and the most for the smallest battery simulated. Note that the lower number of charge stops that can be observed for the aged 87-kWh battery compared to the new battery for the long-distance driver is because of slight variations in the initial SOC at the start of trips.

Figure 14
Effect of battery aging on user convenience, in terms of the number of en-route charge stops for all days (upper section) and commute days (lower section)

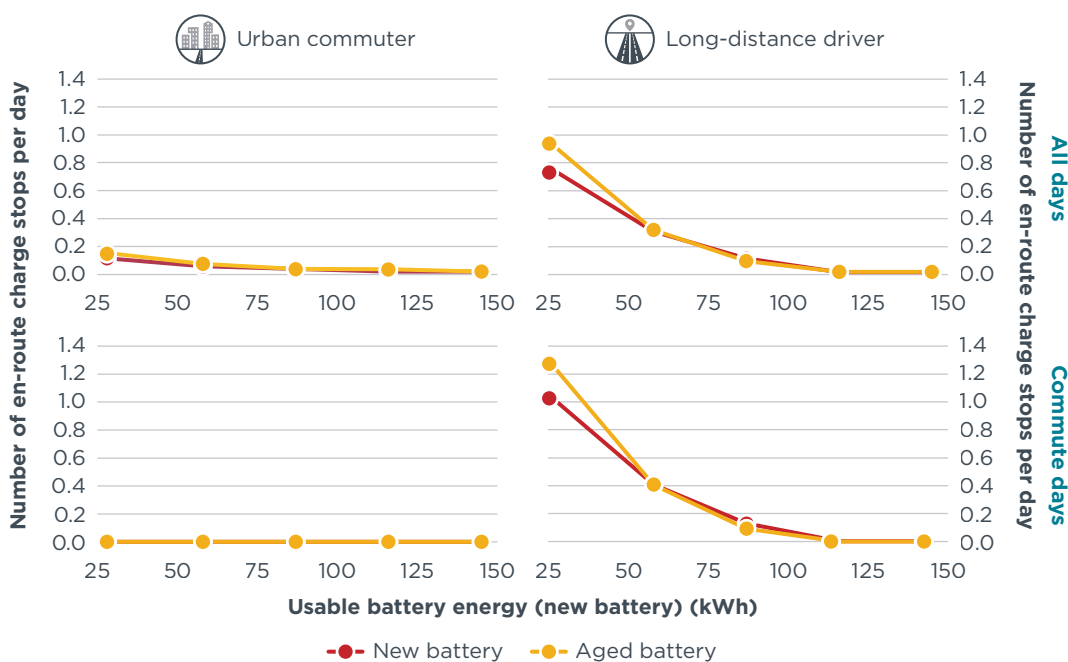

Note: The lower number of charge stops for the aged battery, relative to the new battery for the same battery size, in some situations can be explained by variation in the initial SOC before the trips.

3.5. EFFECT OF BATTERY SIZE ON LIFE-CYCLE GREENHOUSE GAS EMISSIONS

Due to the higher electric energy consumption and GHG emissions related to producing bigger batteries, increasing the battery size is associated with increasing overall GHG emissions, as presented in Figure 15.

Figure 15
Life-cycle greenhouse gas emissions by battery size and user type for a vehicle purchased in 2023

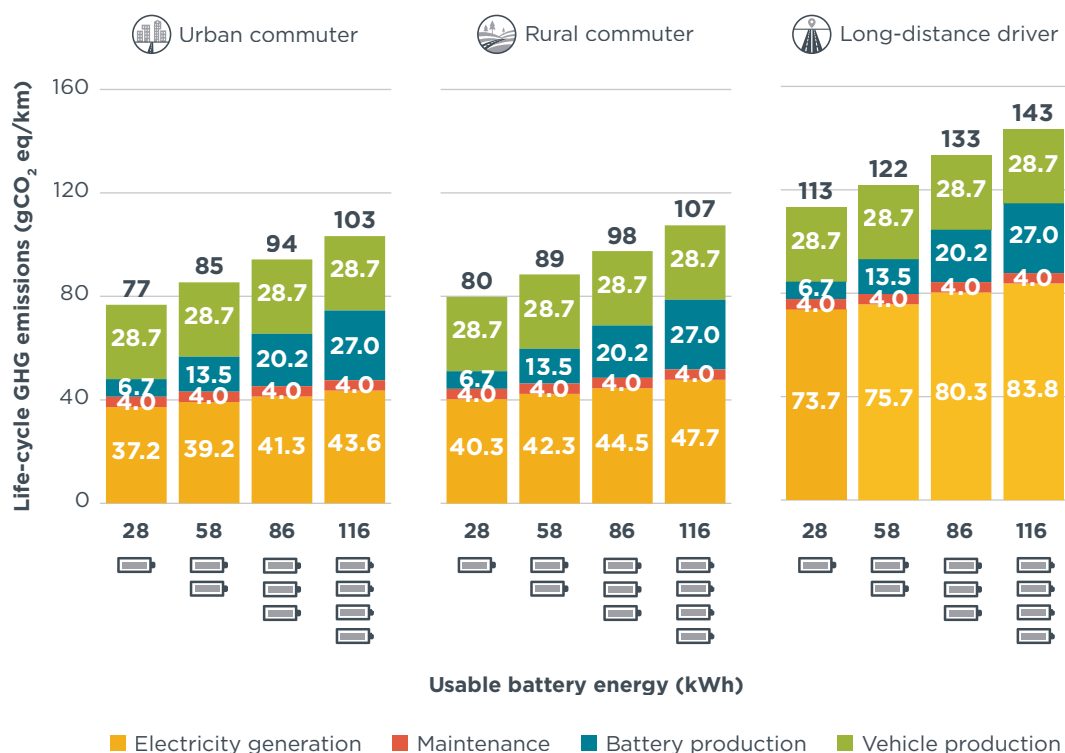

THE INTERNATIONAL COUNCIL ON CLEAN TRANSPORTATION [THEICCT.ORG](https://www.theicct.org)

The observed GHG emissions increase of 3–3.5 gCO₂-eq/km with every 10 kWh of added battery capacity is mainly driven by the increased emissions from the battery production, which has a linear increase of 2.3 gCO₂-eq/km. GHG emissions from electricity generation, which are proportional to the electric energy consumption, increase by around 0.7–1.2 gCO₂-eq/km for every 10 kWh added. As we did not consider the effect of battery size on the vehicle design, and thereby vehicle production, the related emissions remain the same. Emissions related to maintenance are also not considered to change with battery size.

Even though the annual average energy consumption of the long-distance driver is only 2.5% to 5.3% higher than for the urban commuter, as discussed previously, the long-distance driver’s GHG emissions related to electricity generation are about 92%–98% higher. This is related to the assumed higher annual mileage of the long-distance driver, which subsequently shortens the vehicle lifetime and shifts the lifetime energy consumption towards earlier years when grid GHG intensity is high. It is important to note that the annual mileage considered is on the upper end of the range for this user type and, therefore, represents an extreme use case that aggravates the results.

3.6. EFFECT OF BATTERY SIZE ON THE TOTAL COST OF OWNERSHIP

This section presents how increasing the battery size affects the total cost of vehicle ownership for the first owner over a 4-year holding period in Germany. To better understand the differences in the modeled scenarios, the upfront cost and the total ownership costs are presented for the three user types.

The upfront cost, presented in Figure 16, consists of the vehicle net price, VAT, and the proportional cost for home charger installation for the rural commuter and long-distance driver (right). The net vehicle price increases by about €7,510 from one battery size to the next due to the high battery cost. Consequently, the initial investment required by the first owner of a vehicle with the largest 116 kWh battery is about 36% higher than for the 58-kWh model assumed as the baseline. When opting for the lowest-capacity battery of 28 kWh, the upfront cost is 18% less than the baseline model.

Figure 16
Upfront cost by battery size for the three user types

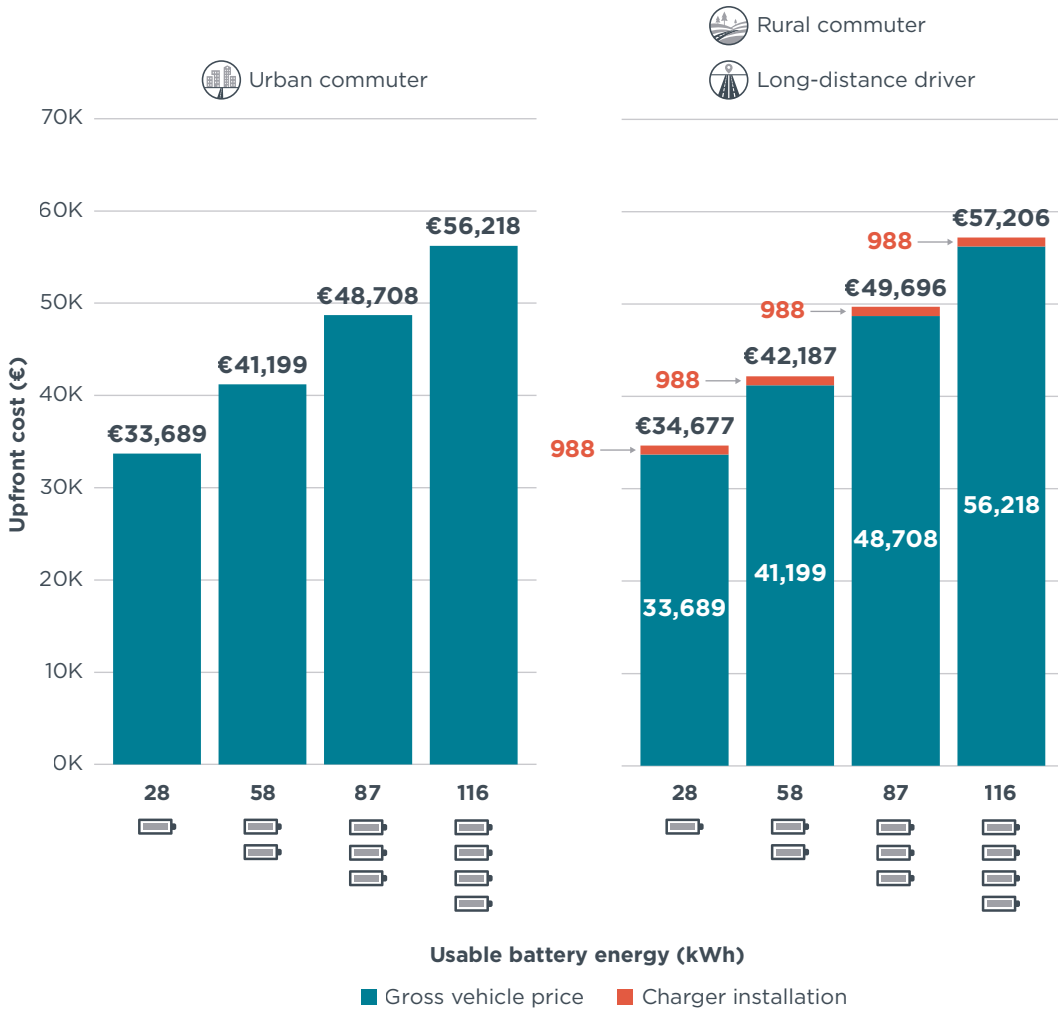

THE INTERNATIONAL COUNCIL ON CLEAN TRANSPORTATION [THEICCT.ORG](https://www.theicct.org)

Since the vehicle holding period considered for the TCO calculation is limited to 4 years, and is thereby shorter than the expected vehicle lifetime, part of the upfront cost is recovered when selling the used vehicle. Therefore, only the depreciated gross vehicle price is considered for the TCO analysis, as shown in Figure 17. The long-distance driver is assumed to keep the vehicle for 4 years, whereas in real life a vehicle that is driven so many kilometers each year is typically company-owned, and is often kept for only 1 to 3 years (Burger & Andreas, 2021). Therefore, the TCO for the long-distance driver presents a worst-case scenario.

Figure 17
Total cost of ownership by component and battery size for the three user types

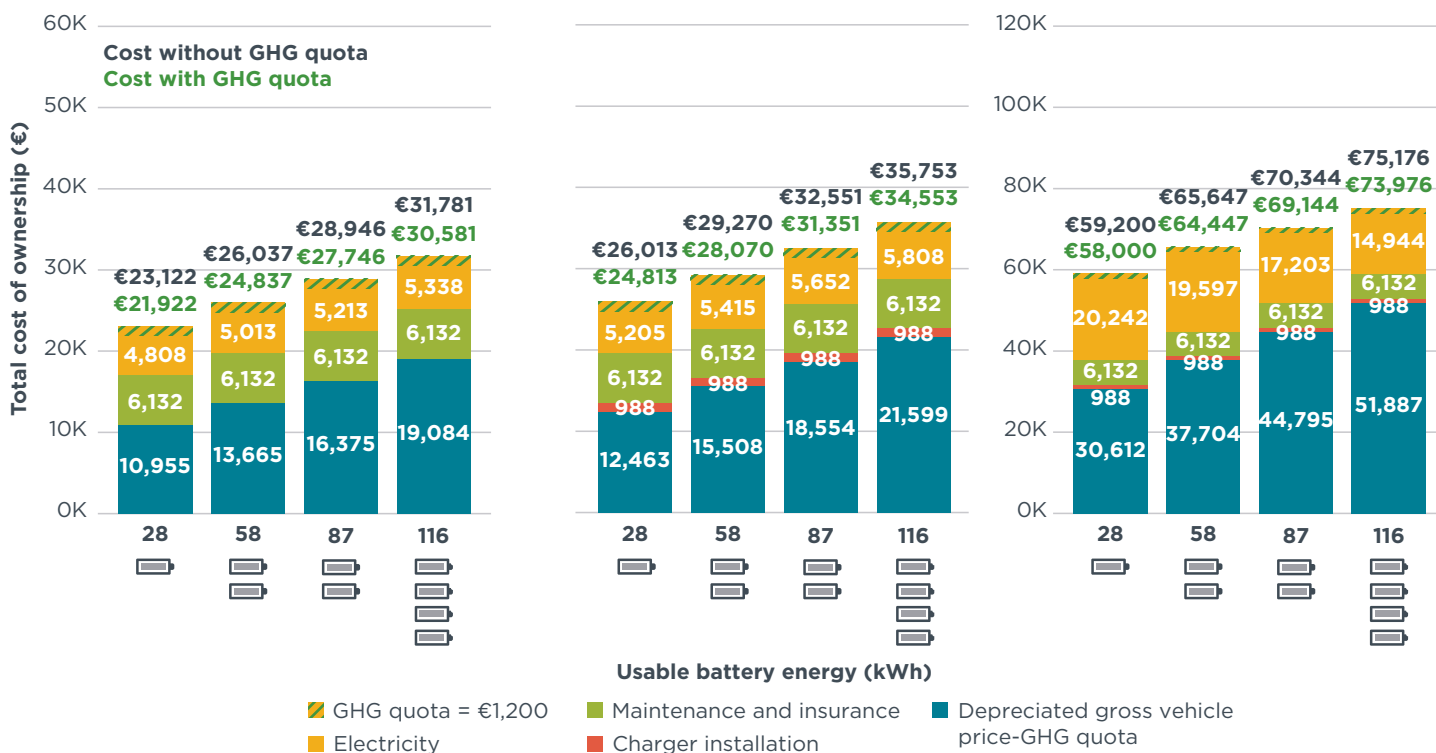

THE INTERNATIONAL COUNCIL ON CLEAN TRANSPORTATION THEICT.ORG

Besides the upfront cost, the TCO is largely affected by the cost of the consumed electric energy. Although the annual average energy consumption increases with battery size, the electricity cost does not increase at the same rate. This is because a larger battery requires fewer en-route charges and thereby avoids the high electricity prices at public fast charging stations. Due to the high number of en-route charging events, the reduction in electricity costs with increased battery size is most pronounced for the long-distance driver. This is also reflected in the average charging rate over 4 years, as shown in Average charging costs over a 4-year holding period used in the total cost of ownership analysis.

Table 8
Average charging costs over a 4-year holding period used in the total cost of ownership analysis

	28 kWh	58 kWh	87 kWh	116 kWh
Urban commuter (€/100 km)	0.44	0.44	0.43	0.42
Rural commuter (€/100 km)	0.43	0.42	0.42	0.41
Long-distance driver (€/100 km)	0.52	0.49	0.41	0.34

Note: The data is shown for three user types as a function of usable battery energy.

However, due to the higher price of vehicles with a larger battery, and therefore a higher amount to be depreciated over the 4-year holding period, the TCO increases with increasing battery size for all user types. The difference in ownership cost between a vehicle with a 28-kWh battery and one with 116-kWh capacity is approximately €8,660 for the urban commuter and €9,740 for the rural commuter. Due to the higher annual mileage of the long-distance driver and the resulting shorter vehicle lifetime, most of the upfront vehicle cost is depreciated after 4 years, contributing to a substantially higher TCO for this user type than for the urban and rural commuter. Despite the lower energy cost, the TCO for the long-distance driver of the 116-kWh vehicle is around €15,980 higher than for the 28-kWh vehicle.

Figure 18 presents the normalized TCO and charging cost in euros per 100 km, using the distance driven during the 4-year holding period. With increasing battery size, the increase in TCO for the urban and rural commuter is steeper than for the long-distance driver. This is because the lower energy cost for the long-distance driver counterbalances some of the higher vehicle cost.

Figure 18
Distance-normalized total cost of ownership and charging cost per 100 km by battery size and user type

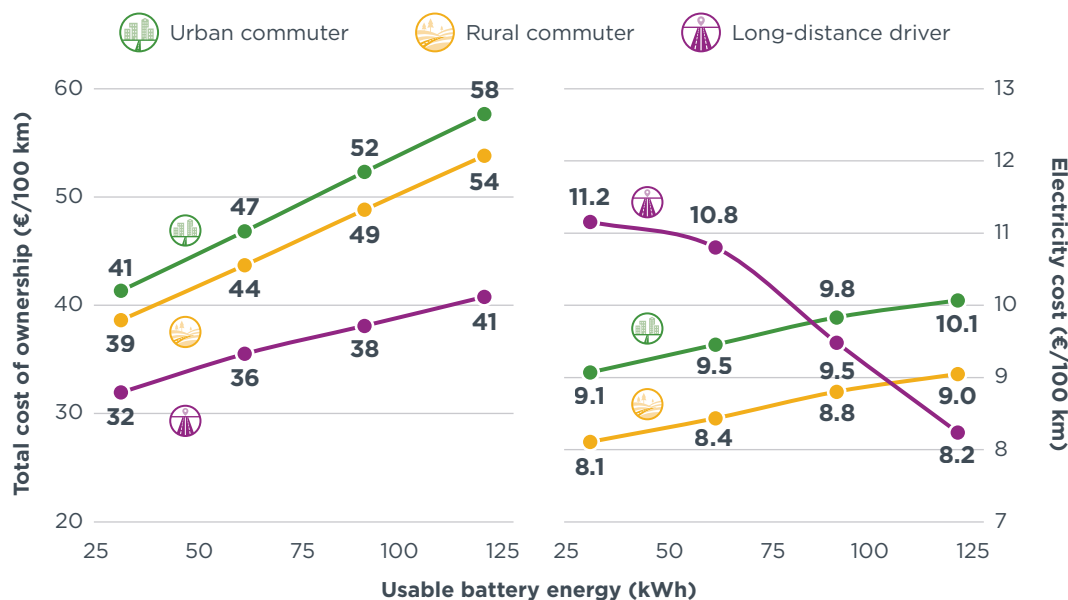

THE INTERNATIONAL COUNCIL ON CLEAN TRANSPORTATION THEICT.ORG

Figure 19 highlights the difference in net charging cost for the different battery sizes relative to the reference case (28-kWh battery vehicle). As shown, the cost difference is driven by two factors: the cost increase due to the added energy consumption and the cost decrease due to the lower average charging rates with bigger battery sizes, as presented in Table 8. From the results, it can be concluded that for all users there is a trade-off between lower charging cost and the cost added due to the increase in energy consumption. For the urban and rural commuters, the net electricity cost oscillates by up to €1/100 km relative to the reference case for the battery sizes considered. When the distances driven are recurrently higher than the battery range so that several en-route DC charging stops are needed, as in case of the long-distance driver, the savings from charging more at home offset the added cost from the increased energy consumption. The €3.9/100 km-lower charging rate for a 116-kWh battery relative to the 28-kWh battery reduces the net charging cost by around €2.9/10 km.

Figure 19

Net electricity cost difference relative to the 28 kWh battery for the three user types

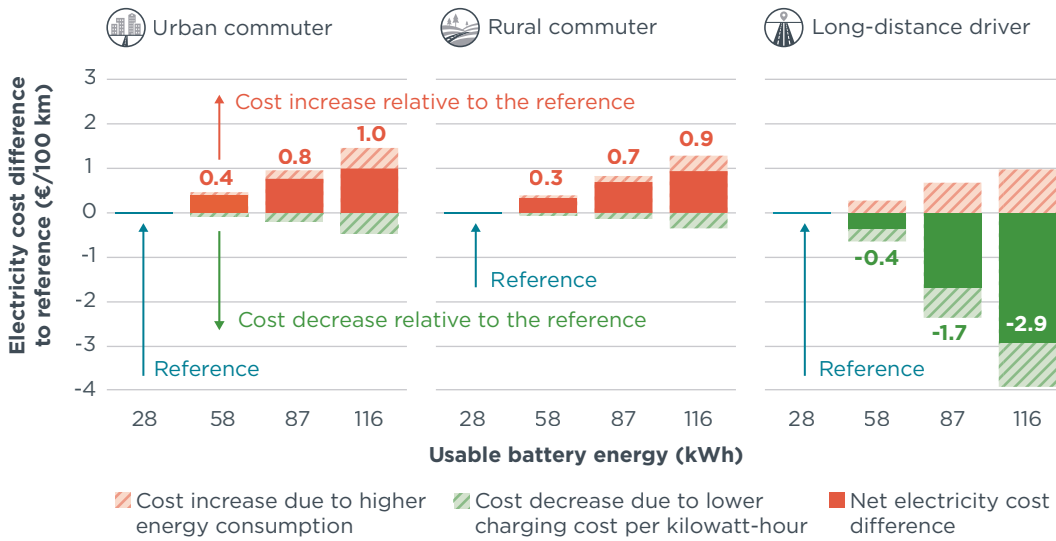

Note: Net electricity cost difference is the total of increasing energy consumption costs for larger batteries minus decreasing charging costs per kilowatt-hour.

THE INTERNATIONAL COUNCIL ON CLEAN TRANSPORTATION THEICT.ORG

3.7. INCREASE OF ELECTRIC RANGE WITH BATTERY SIZE

In addition to providing more usable battery energy, increasing battery size increases energy consumption due to higher vehicle mass, higher charging losses, and higher energy demand of the battery TMS. Therefore, part of the additional capacity is used to compensate for the increased energy consumption and does not add to a longer range, resulting in a less-than-linear increase of range with battery capacity, as shown in Figure 20.

Figure 20

Annual average real-world range as a function of battery size for the three user types

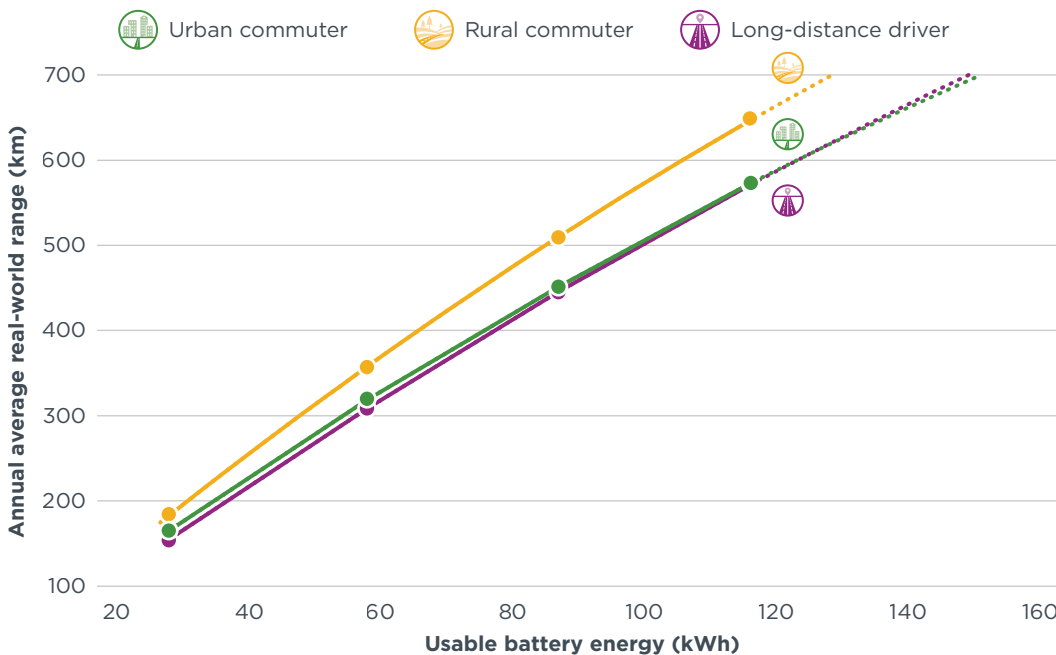

THE INTERNATIONAL COUNCIL ON CLEAN TRANSPORTATION THEICT.ORG

Since consumers are affected by range, and only indirectly by the battery capacity, Figure 21 shows the dependency of life-cycle GHG emissions, 4-year total cost of ownership, and average number of en-route charge stops per day on the average real-world range over one year.

Figure 21
Total cost of ownership, life-cycle GHG emissions, and number of en-route charge stops per day as a function of average real-world range over one year

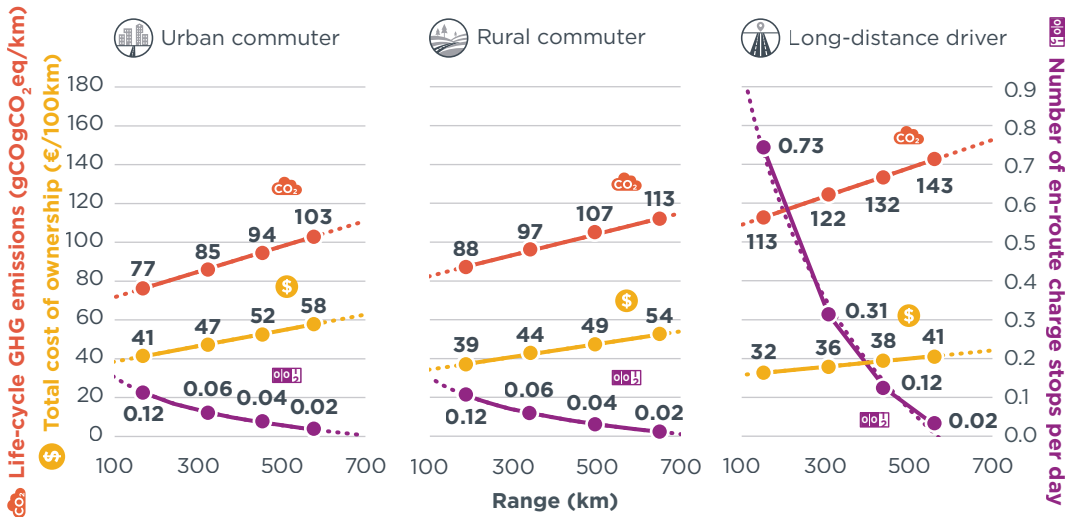

THE INTERNATIONAL COUNCIL ON CLEAN TRANSPORTATION THEICT.ORG

For all users, the life-cycle GHG emissions increase evolves linearly with range. Increasing the real-world range by 100 km adds 6.5 gCO₂-eq/km for the urban commuter, 5.4 gCO₂-eq/km for the rural commuter, and 7.3 gCO₂-eq/km for the long-distance driver.

In terms of the total cost of ownership, increasing the real-world range by 100km adds around €4.0/100km for the urban commuter, €3.3/100km for the rural commuter, and €2.1/100km for the long-distance driver. The number of en-route charge stops per day is reduced by about 23% for the urban and rural driver with every 100 km of battery range added. For the long-distance driver, the effect is more pronounced, as described earlier. Beyond a range of around 600 km, the user convenience in terms of en-route stops does not further improve for all user types, while life-cycle GHG emissions and ownership cost continues to increase.

4. SUMMARY AND RECOMMENDATIONS

This study analyzes how battery size affects BEV energy consumption—and thereby the life-cycle greenhouse gas emissions and total cost of ownership—as well as driver convenience in terms of the number of en-route charging stops. For the assessment, the usage of a compact BEV over the course of one year was simulated for four battery sizes, allowing for a driving range under WLTP type-approval conditions of between 275 km and 784 km. The simulation was performed for three user types: a generic urban commuter, a rural commuter, and a user performing frequent long-distance trips with subsequently high annual mileage.

For all user types, the distance-specific energy consumption increases along with increases in battery size. When annual average real-world range doubles from 250 km to 500 km, the electric energy consumption increases between 8% and 10%, as shown in Figure 22. Together with the higher production of greenhouse gas emissions of the larger battery, doubling the range leads to 15% to 20% higher life-cycle greenhouse gas emissions. Due to the higher vehicle cost driven by the battery cost increase, and the higher cost for the consumed electric energy, the cost per kilometer increases between 15% for the long-distance driver and up to 23% for the urban commuter. User convenience, expressed by the number of en-route charge stops, does not improve for the urban and rural commuters on commute days, which is the most frequent day-type, when doubling the range. For the long-distance driver, one charge stop per commute day on average is avoided. The number of en-route charges on the few leisure long-distance trips per year decreases for the urban commuter and long-distance driver from around four to two, and from five to two for the rural commuter.

Figure 22

Costs and benefits of doubling the average annual real-world range; a comparison for three different user types

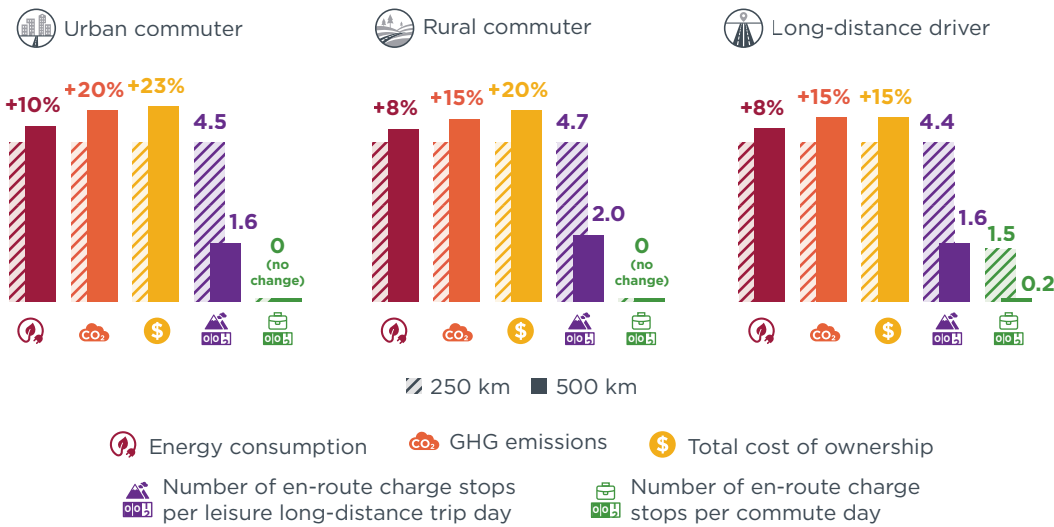

THE INTERNATIONAL COUNCIL ON CLEAN TRANSPORTATION [THEICCT.ORG](https://www.theicct.org)

Based on the results of the study, we arrive at the following conclusions and recommendations:

For the urban and rural commuter use case, the longer range provided by a larger battery is used only during occasional long-distance trips. Most of the year, a larger battery does not provide additional benefits to the urban and rural commuter in terms of avoided en-route fast charging stops. Fast charging along the route is only required when conducting long-distance trips, which in the case of our simulation represents less than 2% of days throughout the year.

For all user types considered, a smaller battery combined with more frequent fast charging is more cost-efficient than the same vehicle with a large battery. A smaller battery requires more frequent fast charging for long-distance travel, which is associated with a higher electricity cost. However, the lower vehicle purchase price and lower energy consumption result in a lower total cost of ownership compared to a vehicle with a larger battery.

Using a small battery and reducing electric energy consumption can achieve low life-cycle greenhouse gas emissions. Life-cycle greenhouse gas emissions increase with increasing battery size, from both producing larger batteries and generating the additional electric energy consumed during vehicle operations. For the same technology, emissions from battery production scale linearly with the size of the installed battery. Although increasing at a lower rate, emissions from electricity generation make up 24%–33% of the total additional emissions produced with every 100 kWh of battery capacity added. At the same time, only the long-distance driver benefits notably from a larger battery.

The real-world energy consumption and range of BEVs are highly influenced by ambient conditions and vehicle usage. Due to the energy consumption of the heating and air conditioning system, as well as of the battery thermal management system, the average energy consumption and the available range vary substantially from month to month. This effect is especially pronounced for users who frequently drive short-distance trips. Consumers would benefit from information regarding the range and energy consumption that can be expected during real-world driving at different ambient conditions and vehicle usage profiles.

Policymakers should consider collecting real-world energy consumption data from BEVs using on-board fuel and energy consumption monitoring (OBFCM) devices. The simulated real-world energy consumption in this study is 29% to 44% higher than the type-approval value. For verifying the representativeness of BEV type-approval values and for comprehensive consumer information, reliable real-world energy consumption data would be essential. However, BEVs are currently not required to have OBFCM devices.

REFERENCES

- ADAC. (n.d.-a). VW ID.3 Pro Performance (09/20–05/21): Technische daten, Bilder, Preise [Technical data, pictures, prices]. Retrieved February 6, 2024, from <https://www.adac.de/rund-ums-fahrzeug/autokatalog/marken-modelle/vw/id3/1generation/313859/#kosten>
- ADAC. (n.d.-b) ADAC info—Autodatenbank Vergleichsseite [Car database comparison site]. Retrieved February 6, 2024, from <https://www.adac.de/rund-ums-fahrzeug/autokatalog/marken-modelle/fahrzeugvergleich/>
- ADAC (n.d.-c) THG-Quote: Mind. 100€ Prämie in 2024 [GHG quota: Min. €100 bonus in 2024]. Retrieved February 6, 2024, from <https://www.adac.de/rund-ums-fahrzeug/e-angebote/thg-bonus/>
- ADAC. (2023, March 30). Das kostet der Einbau einer Wallbox [Wallbox: Costs for installing a charging station]. <https://www.adac.de/rund-ums-fahrzeug/elektromobilitaet/laden/wallbox-kosten/>
- ADAC. (2024, January 11). Umweltbonus: Plötzliches aus für die Förderung von E-autos [Environmental bonus: Sudden end for the promotion of electric cars]. <https://www.adac.de/rund-ums-fahrzeug/elektromobilitaet/kaufen/foerderung-elektroautos/>
- Arval Mobility Observatory. (2022). Was ist die jährliche durchschnittliche Kilometerleistung pro Fahrzeug in ihrer Flotte? [What is the annual average mileage per vehicle in your fleet?] [Graphic]. Statista. <https://de.statista.com/statistik/daten/studie/1178125/umfrage/umfrage-zur-durchschnittlichen-kilometerleistung-pro-fahrzeug-in-unternehmen/>
- Basma, H., & Rodríguez, F. (2022). Fuel cell electric tractor-trailers: technology overview and fuel efficiency. International Council on Clean Transportation. <https://theicct.org/publication/fuel-cell-tractor-trailer-tech-fuel-jul22/>
- Bieker, G. (2021). A global comparison of the life-cycle greenhouse gas emissions of combustion engine and electric passenger cars. International Council on Clean Transportation. <https://theicct.org/publications/global-LCA-passenger-cars-jul2021>
- Bieker, G., Moll, C., Link, S., Plötz, P., & Mock, P. (2022). More bang for the buck: A comparison of the life-cycle greenhouse gas emission benefits and incentives of plug-in hybrid and battery electric vehicles in Germany. International Council on Clean Transportation. <https://theicct.org/publication/ghg-benefits-incentives-ev-mar22/>
- Bloomberg NEF. (2022, December 6). Lithium-ion battery pack prices rise for first time to an average of \$151/kWh. <https://about.bnef.com/blog/lithium-ion-battery-pack-prices-rise-for-first-time-to-an-average-of-151-kwh/>
- Bundesanstalt für Straßenwesen. (2017). Fahrleistungserhebung 2014—Inländerfahrleistung [Mileage survey 2014—National mileage]. Bundesanstalt für Straßenwesen. <https://bast.opus.hbz-nrw.de/frontdoor/index/index/docId/1774>
- Bundesministerium für Digitales und Verkehr. (2017). Mobilität in Deutschland 2017—MiD 2017 [Mobility in Germany 2017 —MiD 2017]. <https://www.mobilitaet-in-deutschland.de/archive/publikationen2017.html>
- Burger, A., & Bretschneider, W. (2021). Umweltschädliche Subventionen in Deutschland: Aktualisierte Ausgabe 2021 [Environmentally harmful subsidies in Germany: Updated edition 2021]. Umweltbundesamt. https://www.umweltbundesamt.de/sites/default/files/medien/479/publikationen/texte_143-2021_umweltschaedliche_subventionen.pdf
- Check24. (n.d.). Wertverlust beim Auto: Berechnen & Tabelle [Loss of car value: Calculation and table]. Retrieved July 3, 2023, from <https://www.check24.de/kfz-versicherung/automagazin/ratgeber/wertverlust-auto/>
- de Kwaasteniet, A. (2022). EV's energy consumption. Retrieved October, 4 2023, from https://docs.google.com/spreadsheets/d/1x4Dyf_HkXDoXnuh6rJ5zZeH313fVaMIi4qPCmkmBtuw/edit#gid=1768997915
- Deutscher Wetterdienst. (n.d.). [dataset for 2021]. https://www.dwd.de/EN/weather/weather_climate_local/berlin-brandenburg/bbb_node.html
- Directive 1999/94/EC of the European Parliament and of the Council of 13 December 1999 relating to the availability of consumer information on fuel economy and CO2 emissions in respect of the marketing of new passenger cars, OJ L 12, 6-23 (2000). <https://eur-lex.europa.eu/eli/dir/1999/94/2008-12-11>
- Dornoff, J., German, J., Deo, A., & Dimaratos, A. (2022). Mild-hybrid vehicles: A near term technology trend for CO2 emissions reduction. International Council on Clean Transportation. <https://theicct.org/wp-content/uploads/2022/07/mild-hybrid-emissions-jul22.pdf>
- Elli (n.d.). Volkswagen ID. Charger—Die Wallbox für zuhause [Volkswagen ID. charger—Wallbox for home]. Volkswagen Group Charging (Elli). Retrieved February 6, 2024, from <https://vw.elli.eco/de-DE/shop/id-charger>
- EnBW. (2023, April 3). Was ist der Unterschied zwischen AC- und DC-Laden? [Charging an electric car with AC or DC: What is the difference?]. <https://www.enbw.com/blog/elektromobilitaet/laden/grundwissen-was-ist-der-unterschied-zwischen-ac-und-dc-laden/>

- TransportPolicy.Net. (n.d.). EU: Light-duty: Artemis. Retrieved November 1, 2023, from <https://www.transportpolicy.net/standard/eu-light-duty-artemis/>
- European Alternative Fuels Observatory. (2022, October 31). Electric vehicle recharging prices. European Commission. Retrieved July 3, 2023, from <https://alternative-fuels-observatory.ec.europa.eu/consumer-portal/electric-vehicle-recharging-prices>
- European Commission. (2022, November 10). Commission proposes new Euro 7 standards to reduce pollutant emissions from vehicles to improve air quality [Press release]. https://ec.europa.eu/commission/presscorner/detail/en/ip_22_6495
- European Commission, Directorate-General for Climate Action. (2020). Determining the environmental impacts of conventional and alternatively fuelled vehicles through LCA—Final report. Publications Office of the European Union. <https://data.europa.eu/doi/10.2834/91418>
- European Environment Agency. (2022, June 9). Monitoring of CO2 emissions from passenger cars - Regulation (EU) 2019/631 [Dataset]. Retrieved August 24, 2023, from <https://www.eea.europa.eu/data-and-maps/data/co2-cars-emission-20>
- Eurostat. (2022). Electricity prices for household consumers—Bi-annual data (from 2007 onwards) (nrg_pc_204). Retrieved July 3, 2023, from https://ec.europa.eu/eurostat/cache/metadata/EN/nrg_pc_204_sims_no.htm
- EV Database. (n.d.). Volkswagen ID.3 Pro Performance. Retrieved July 3, 2023, from <https://ev-database.org/car/1306/Volkswagen-ID3-Pro-Performance>
- Großmann, H., & Böttcher, C. (2020). Luftstrom durch den Fahrgastraum [Air flow through the passenger compartment]. In H. Großmann & C. Böttcher, Pkw-Klimatisierung (pp. 35-71). Springer Berlin Heidelberg. https://doi.org/10.1007/978-3-662-59616-6_3
- Helms, H., Bruch, B., Räder, D., Hausberger, S., Lipp, S., & Matzer, C. (2022). Energieverbrauch von Elektroautos (BEV) [Energy consumption of electric cars (BEV)]. Umweltbundesamt. https://www.umweltbundesamt.de/sites/default/files/medien/479/publikationen/texte_160-2022_energieverbrauch_von_elektroautos.pdf
- International Council on Clean Transportation. (2023). European Vehicle Market Statistics—Pocketbook 2022/2023. <https://theicct.org/publication/european-vehicle-market-statistics-2022-23/>
- International Energy Agency. (2022). Global EV Outlook 2022. <https://www.iea.org/reports/global-ev-outlook-2022>
- Kok, I., & Hall, D. (2023). Battery electric and plug-in hybrid vehicle uptake in European cities. International Council on Clean Transportation. <https://theicct.org/publication/bev-phev-european-cities-mar23/>
- Lindgren, J., & Lund, P. D. (2016). Effect of extreme temperatures on battery charging and performance of electric vehicles. *Journal of Power Sources*, 328, 37-45. <https://doi.org/10.1016/j.jpowsour.2016.07.038>
- Mao, S., Niu, T., Basma, H., Yang, L., Wang, C., & Ren, J. (2023). Greenhouse gas emissions reduction potential of CO2-based mobile air conditioning systems in China's electric bus fleets. International Council on Clean Transportation. <https://theicct.org/publication/ghg-reduction-of-co2-mvac-electric-buses-china-sept23/>
- Mehlig, D., Muller, M., Treier, J., & Loges, A. (2021). Long distance e-mobility in the trade-off between battery capacity & charging power – Battery immersion cooling as enabler technology? In 20th International Congress and Exhibition ELIV 2021: October 20-21, 2021, in Bonn, Germany or via live stream (VDI-Berichte vol. 2384, pp. 545-562). VDI Verlag GmbH. <https://doi.org/10.51202/9783181023846-545>
- Moomaw, W., Burgherr, P., Heath, G., Lenzen, M., Nyboer, J., & Verbrugge, A. (2011). Annex II: Methodology. In Renewable energy sources and climate change mitigation. Intergovernmental Panel on Climate Change. <https://www.ipcc.ch/site/assets/uploads/2018/03/>
- Regulation (EU) 2023/851 of the European Parliament and of the Council of 19 April 2023 Amending Regulation (EU) 2019/631 as Regards Strengthening the CO2 Emission Performance Standards for New Passenger Cars and New Light Commercial Vehicles in Line with the Union's Increased Climate Ambition, Pub. L. No. (EU) 2023/851, OJ L 110, 5-20 (2023). <https://eur-lex.europa.eu/eli/reg/2023/851>
- Tobin, T (2020, July 30). What is the expected lifespan of an EV charger? GROK EV Charger Services. Retrieved February 6, 2024, from <https://grokev.ca/faq/what-is-the-expected-lifespan-of-an-ev-charger/>
- Wassiliadis, N., Steinräter, M., Schreiber, M., Rosner, P., Nicoletti, L., Schmid, F., Ank, M., Teichert, O., Wildfeuer, L., Schneider, J., Koch, A., König, A., Glatz, A., Gandlgruber, J., Kröger, T., Lin, X., & Lienkamp, M. (2022). Quantifying the state of the art of electric powertrains in battery electric vehicles: Range, efficiency, and lifetime from component to system level of the Volkswagen ID.3. *eTransportation*, 12, 100167. <https://doi.org/10.1016/j.etrans.2022.100167>

APPENDIX

APPENDIX A. VEHICLE MODEL PARAMETERS

Figure A1

Temperature-dependent battery discharge resistance and open circuit voltage of the simulated battery

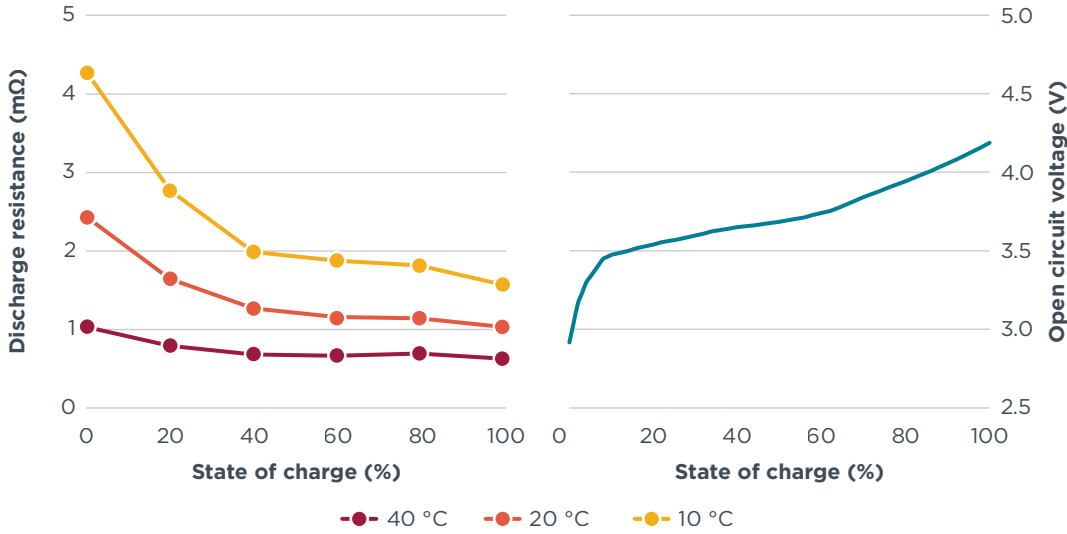
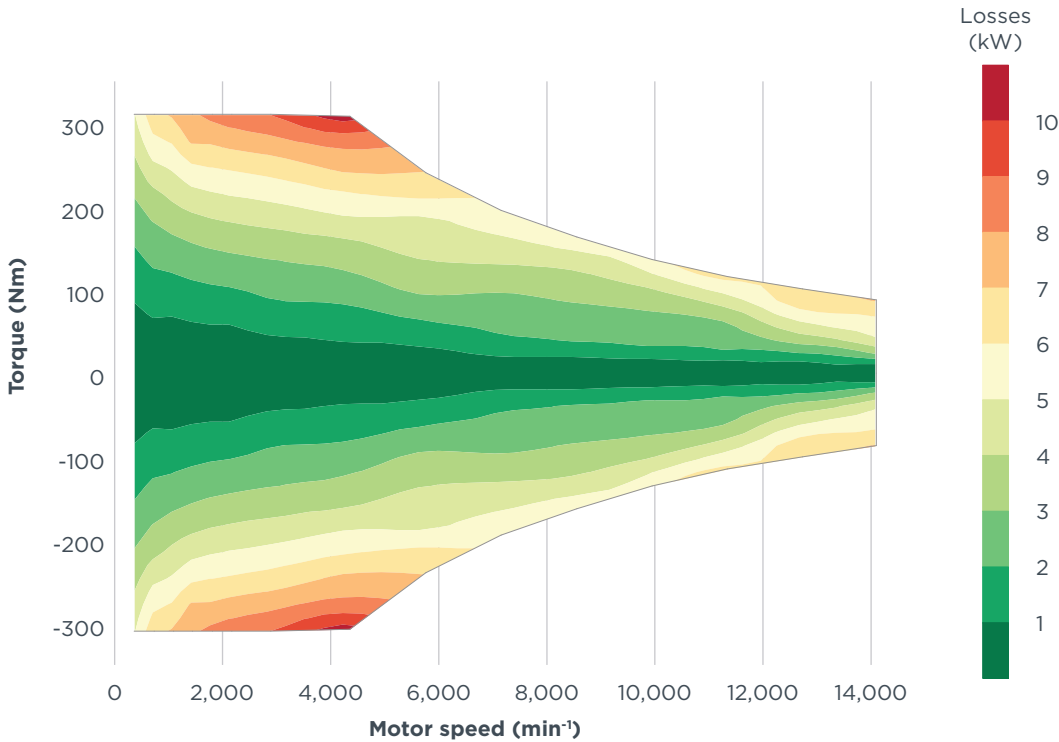

Figure A2

Losses of the electric motor including inverter, dependent on motor speed and torque



APPENDIX B. COEFFICIENT OF PERFORMANCE (COP) OF SIMULATED R-744 (CO₂) HEAT PUMP FOR HEATING AND COOLING

Figure B1

COP as a function of ambient temperature for both heating and cooling modes of a heat pump running on R-744

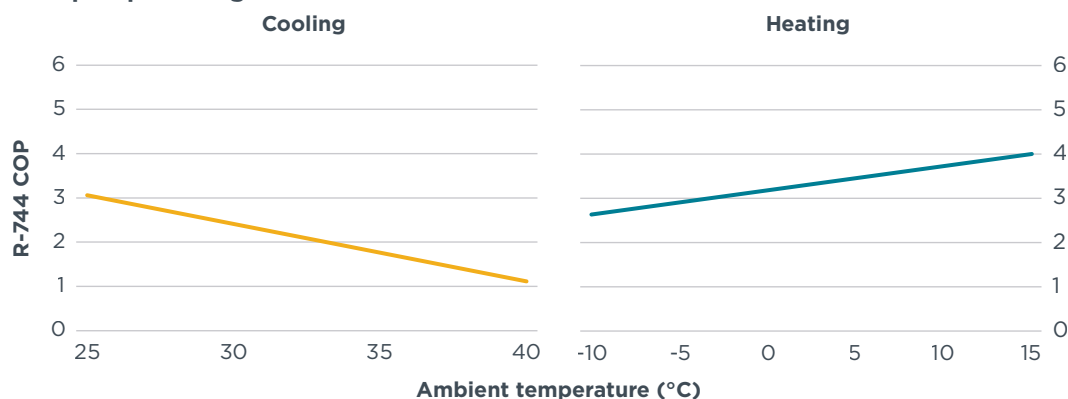

Note: Results derived from a recent ICCT study (Mao et al., 2023)

APPENDIX C. THERMAL MANAGEMENT SYSTEM CONTROL STRATEGY

Table C1

Thermal management system control strategy implemented in the simulation model

State	Cabin compressor power (P_{cab})	Cabin temperature setpoint (T_{set}) and thermal control activation threshold (T_{cab})	Battery compressor power (P_{bat})	Battery temperature setpoint (T_{set}) and thermal control activation threshold (T_{bat})
Rural commuter and long-distance driver before first trip per day	$P_{cab} = 0$ W	—	—	Cooling mode: $T_{bat} > 25^{\circ}\text{C}$, $T_{set} = 24^{\circ}\text{C}$ Heating mode: $T_{bat} < 15^{\circ}\text{C}$, $T_{set} = 20^{\circ}\text{C}$ PTC auxiliary heater operates while $T_{bat} < 5^{\circ}\text{C}$
Normal driving	$P_{cab} = 3000 - P_{bat}$ W (with control system)	Cooling mode: $T_{cab} > 26^{\circ}\text{C}$, $T_{set} = T_{cab} = 23^{\circ}\text{C}$ Heating mode: $T_{cab} < 20^{\circ}\text{C}$, $T_{set} = T_{cab} = 23^{\circ}\text{C}$	Cooling mode: $P_{comp,bat} = P_{maxbat}$ W Heating mode: $P_{comp,bat} = P_{maxbat} / 2$ W $P_{PTC,bat} = 6000$ W	Cooling mode: $T_{bat} > 31.5^{\circ}\text{C}$, $T_{set} = 32.5^{\circ}\text{C}$ Heating mode: $T_{bat} < 10$, $T_{set} = 15^{\circ}\text{C}$ PTC auxiliary heater operates while $T_{bat} < 5^{\circ}\text{C}$
Before fast charging, while driving, and during fast charging	$P_{cab} = 3000 - P_{bat}$ W (with control system)	Cooling mode: $T_{cab} > 26^{\circ}\text{C}$, $T_{set} = T_{cab} = 23^{\circ}\text{C}$ Heating mode: $T_{cab} < 20^{\circ}\text{C}$, $T_{set} = T_{cab} = 23^{\circ}\text{C}$	Cooling mode: $P_{comp,bat} = P_{maxbat}$ W Heating mode: $P_{comp,bat} = P_{maxbat} / 2$ W $P_{PTC,bat} = 6000$ W	Cooling mode: $T_{bat} > 30^{\circ}\text{C}$, $T_{set} = 25^{\circ}\text{C}$ Heating mode: $T_{bat} < 25^{\circ}\text{C}$, $T_{set} = 20^{\circ}\text{C}$ PTC auxiliary heater operates while $T_{bat} < 5^{\circ}\text{C}$
All others	$P_{cab} = 0$ W	—	$P_{bat} = 0$ W	—

APPENDIX D. CHARGING LOSSES

AC on-board charger losses were determined based on the information available from EV Database (n.d.). The database provides two energy consumption estimates: one at the battery level and the other accounting for charging losses, including losses at the on-board charger level and internal battery charging losses. To determine AC charging losses at the on-board charger level decoupled from internal charging losses, we compared energy consumption with charging losses as reported in EV Database with the simulation of the WLTP procedure, assuming an onboard charger efficiency of 100%. The difference was assumed to correspond to the on-board charger losses (AC/DC conversion losses). These losses, set as a constant value, were iteratively adjusted to match the energy consumption values with charging losses from the simulation of the WLTP procedure, set at 12% by the end of the process.

To estimate DC fast charging conversion losses, a literature review was carried out. However, literature data is scarce; the most detailed data source we found provided measurements made by a private user who carried out charging and discharging tests on several vehicles at different power levels, measuring total charging losses. We have aggregated the data from the vehicles tested with a charging power above 70W and determined the trendline by linear least squares regression. As shown in Figure D1, the average total charging efficiency obtained can be considered constant and around 93% (7% external losses). The DC conversion losses were adjusted to match the external losses in the simulation model, which resulted in the 4% conversion losses in our model. Source: de Kwaasteniet, 2022 summarizes these assumptions.

Figure D1
DC fast charging efficiency data as measured by a private user

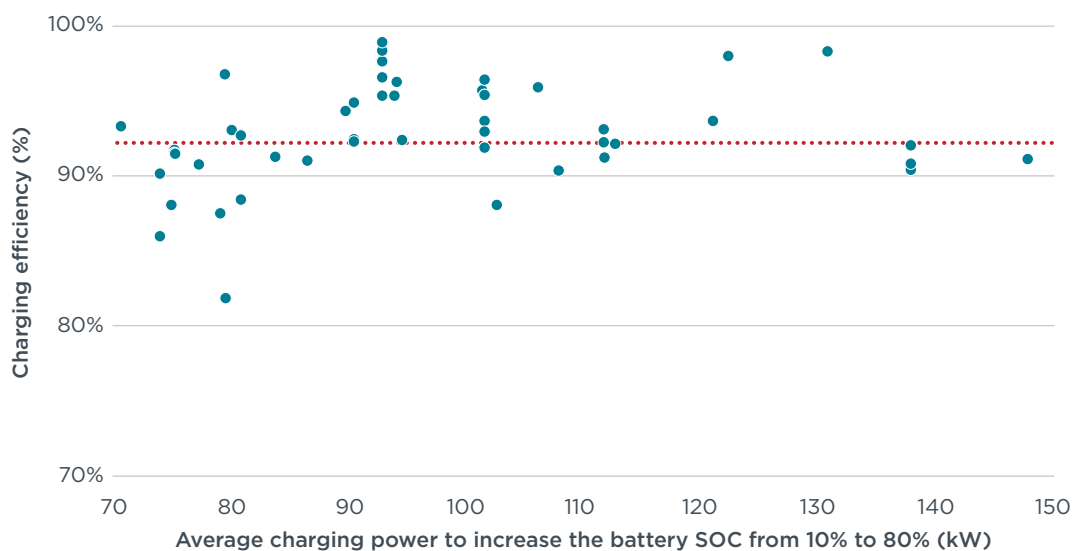

Source: de Kwaasteniet (2022)

Table D1
Losses in charging devices during AC and DC charging

Charging type	Charging loss source	Model	Value
AC charging	On-board charger	11 kW, 12% conversion losses (leading to a total of 16% charging losses under WLTP testing)	17.5% ¹
DC charging	External charger	100 kW, 4% conversion losses (leading to a total of around 10% losses under WLTP testing)	7% total charging losses ²

¹ Helms et al. (2022)

² de Kwaasteniet (2022)

APPENDIX E. DAILY TRIPS AND DRIVE CYCLES

To realistically represent speed profiles in the simulation model, the urban, rural road, and motorway speed profiles of the Common Artemis Drive Cycle 130 are used as described in Table E1 and Figure E1.

Table E1

Characteristics of the Common Artemis Drive Cycle 130 used in the simulation analysis

Cycle	Duration (s)	Distance (km)	Average speed (km/h)	Maximum speed (km/h)
Urban	993	4.874	17.7	57.3
Rural Road	1,082	17.275	57.5	111.1
Motorway 130	1,068	28.737	96.9	131.4

Source: TransportPolicy.Net (n.d.)

Figure E1

Speed profile of the Common Artemis Drive Cycle 130 urban, rural road, and motorway sections

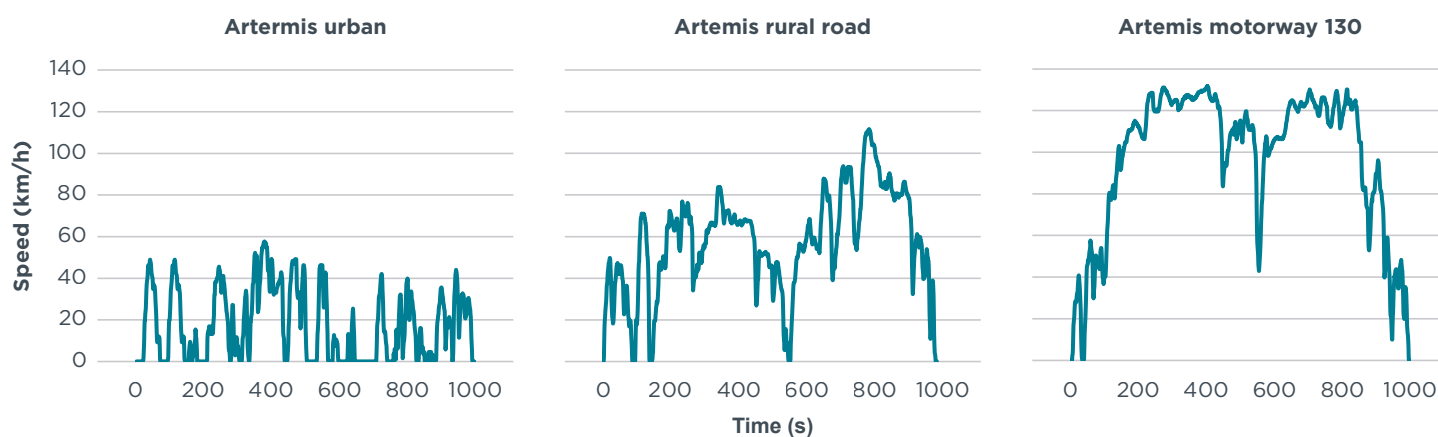

APPENDIX F. TOTAL COST OF OWNERSHIP (TCO) ANALYSIS ASSUMPTIONS

Table F1

Assumptions made for the different cost components of the TCO analysis

TCO component	Value and description
Upfront cost	
Vehicle cost	The ID.3 vehicle first-user cost is based on the ADAC cost comparator tool, with the €1,071 net cost of the optional heat pump added. (ADAC, n.d.-b) The vehicle depreciation assumption is based on the annual average vehicle mileage and is explained below in more detail.
Value-added tax	The current German value-added tax (VAT) of 19% is used.
Charger installation	The literature suggests that there is a wide price range for the cost of the charger and installation depending on the location, building characteristics, etc. Therefore, we assume a charger cost of €769— which is the best-selling equipment for VW vehicles according to the seller's website (Elli, n.d.)— and the average range values for installation cost of €1,700 (ADAC, 2023). According to industry experts, a lifetime of 10 years can be expected for the charger, which means 40% of the total cost is depreciated over the 4-year TCO period (Tobin, 2020).
Running cost	
Base electricity price	The household electricity price of €0.3018/kWh, including all taxes and levies, is derived from the Eurostat German annual average electricity price in 2022 for household consumers with an annual consumption of 5,000–14,999 kWh (Eurostat, 2022). The public charging rates are derived from this value, as explained.
Maintenance	Maintenance costs are derived from ADAC vehicle cost databases for the ID.3 Pro Performance (ADAC, n.d.-a). For an ownership period of 3 years or 80,000 km driven, the costs of the vehicle amounted to €57/month. For this study, we assume this amount to be independent of the annual mileage.
Insurance	Rates derived from ADAC amounting to €849 per year include full-comprehensive insurance with a deductible of €500 and a 0% no-claims bonus (ADAC, n.d.-a).
Subsidies	
GHG quota	The GHG quota is an instrument from the German federal government which pays consumers who utilize low emission-based modes of travel. We assume €300 can be obtained per year, according to ADAC ratings for e-cars (ADAC, n.d.-c).

Vehicle depreciation

Check24 (n.d.) presents an average depreciation curve based on the vehicle's calendar age for second-hand cars sold in Germany. After 1 year the vehicle has lost 25% of its value; after 3 years 33% of the value is lost; and from the third to the tenth year the annual loss, relative to the initial value, increases at a constant rate of around 5%. After 10 years, the loss in value is equal to 80%.

In our analysis, we assume that vehicle depreciation per year is a function of its mileage. That means that for the case of the long-distance driver, who covers higher distances over the year, the car will depreciate faster than for the other two users. To determine the depreciation in terms of vehicle mileage instead of age, we assume that a car travels 16,000 km per year on average. Assuming that a vehicle is fully depreciated after 240,000 km, the depreciation period for the average car is 15 years, with a constant rate after 10 years. By expressing the above-mentioned assumptions in

terms of kilometers driven, we obtain the depreciation after 4 years for each user type, as summarized in Table F1.

Table F1
Assumed vehicle depreciation rates included in the TCO analysis

User type	Mileage after 4 years (km)	Depreciation
Urban commuter	53,024	36.1%
Rural commuter	64,208	40.6%
Long-distance driver	181,432	94.4%

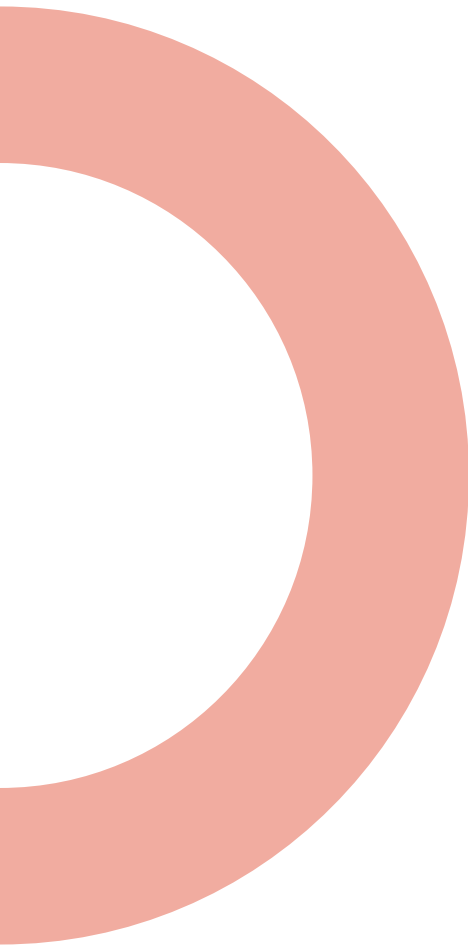

www.theicct.org

communications@theicct.org

[@theicct.org](https://twitter.com/theicct.org)

icct
THE INTERNATIONAL COUNCIL
ON CLEAN TRANSPORTATION